Power Panel C-Series

User's Manual

Version: 1.00 (October 2014)
Model no.: MAPPC-ENG

Everything for your HMI running



Touch.Keypad.Display

✉ sales@vicpas.com

☎ +86-15876525394

Chapter 1 General information.....	4
1 Manual history.....	4
2 Safety guidelines.....	4
2.1 Introduction.....	4
2.2 Intended use.....	4
2.3 Protection against electrostatic discharge.....	4
2.3.1 Packaging.....	5
2.3.2 Guidelines for proper ESD handling.....	5
2.4 Transport and storage.....	5
2.5 Installation.....	5
2.6 Operation.....	6
2.6.1 Protection against touching electrical parts.....	6
2.6.2 Environmental conditions - Dust, humidity, aggressive gases.....	6
2.6.3 Viruses and dangerous programs.....	6
2.7 Organization of safety notices.....	6
Chapter 2 Power Panel C-Series.....	7
1 System features.....	7
1.1 Compact solution.....	7
1.2 Simple programming.....	7
1.3 Power Panel C70.....	8
1.4 Flexibility.....	8
1.5 Order number key.....	9
2 C-Series.....	10
2.1 Selecting a Power Panel.....	10
2.2 General technical data.....	10
2.3 Overview.....	11
2.3.1 Overview - 4PPC70.057x.....	11
2.3.2 Overview - 4PPC70.070x.....	11
2.3.3 Overview - 4PPC70.101x.....	11
2.3.4 Interfaces.....	12
2.4 4PPC70.xxxx-2xx.....	13
2.4.1 4PPC70.057x-2xx.....	13
2.4.2 4PPC70.070x-2xx.....	29
2.4.3 4PPC70.101x-2xx.....	45
2.4.4 Diagnostic LEDs.....	61
2.4.5 Reset button.....	63
2.4.6 Temperature/Humidity diagram.....	64
2.4.7 Connection elements.....	65
2.4.8 Dimensions.....	72
Chapter 3 Installation.....	78
1 Installation instructions.....	78
2 Mounting orientations.....	79
3 Commissioning.....	80
4 Grounding.....	82
5 Touch screen.....	83
5.1 Touch screen calibration.....	83
5.2 Operating the touch screen.....	83
6 Screen rotation.....	83
Chapter 4 Standards and certifications.....	84
1 Applicable European directives.....	84
2 Overview of standards.....	84
3 International certifications.....	84

Chapter 5 Accessories.....	85
1 Overview.....	85
2 TB102 2-pin power supply connector.....	86
2.1 Order data.....	86
2.2 Technical data.....	86
3 TB510x 4/6-pin terminal block.....	87
3.1 Order data.....	87
3.2 Technical data.....	87
4 Data storage media.....	87
5 Cable accessories.....	87
 Chapter 6 Maintenance.....	 88
1 Cleaning.....	88
2 Screen burn-in on LCD/TFT monitors.....	88
 Chapter 7 Technical information.....	 89
1 Panel overlay.....	89
2 Viewing angles.....	89

Chapter 1 • General information

Information:

B&R keeps the printed version of user's manuals as current as possible. If a newer version of the user's manual is available, it can always be downloaded in electronic form (PDF) from the B&R website www.br-automation.com

1 Manual history

Version	Date	Comment
0.10	July 2014	First edition
0.11	August 2014	Updated "Technical data"
0.12	September 2014	Updated "Technical data"
0.20	September 2014	"Installation instructions" & "Mounting orientations" updated
0.21	September 2014	Updated "Technical data"
1.00	October 2014	"Technical data", "Commissioning" & "Accessories" updated

Table 1: Manual history

2 Safety guidelines

2.1 Introduction

Programmable logic controllers (PLCs), operating and monitoring devices (industrial PCs, Power Panels, Mobile Panels, etc.), as well as the B&R uninterruptible power supplies have been designed, developed or manufactured for conventional use in industry. They were not designed, developed and manufactured for any use involving serious risks or hazards that could lead to death, injury, serious physical damage or loss of any kind without the implementation of exceptionally stringent safety precautions. In particular, such risks and hazards include the use of these devices to monitor nuclear reactions in nuclear power plants, their use in flight control or flight safety systems as well as in the control of mass transportation systems, medical life support systems or weapons systems.

When using programmable logic controllers or operating/monitoring devices as control systems together with a Soft PLC (e.g. B&R Automation Runtime or comparable product) or Slot PLC (e.g. B&R LS251 or comparable product), safety precautions relevant to industrial control systems (e.g. the provision of safety devices such as emergency stop circuits, etc.) must be observed in accordance with applicable national and international regulations. The same applies for all other devices connected to the system, e.g. drives.

All tasks such as the installation, commissioning and servicing of devices are only permitted to be carried out by qualified personnel. Qualified personnel are those familiar with the transport, mounting, installation, commissioning and operation of devices who also have the appropriate qualifications (e.g. IEC 60364). National accident prevention regulations must be observed.

The safety notices, connection descriptions (type plate and documentation) and limit values listed in the technical data are to be read carefully before installation and commissioning and must be observed.

2.2 Intended use

Electronic devices are never completely failsafe. If the programmable control system, operating/monitoring device or uninterruptible power supply fails, the user is responsible for ensuring that other connected devices, e.g. motors, are brought to a secure state.

2.3 Protection against electrostatic discharge

Electrical components that can be damaged by electrostatic discharge (ESD) must be handled accordingly.

2.3.1 Packaging

- Electrical components with a housing
... do not require special ESD packaging, but must be handled properly (see "Electrical components with a housing" on page 5).
- Electrical components without a housing
... are protected by ESD-suitable packaging.

2.3.2 Guidelines for proper ESD handling

Electrical components with a housing

- Do not touch the contacts of connectors on the device (bus data contacts)
- Do not touch the connector contacts on connected cables.
- Do not touch the contact tips on circuit boards.

Electrical components without a housing

The following applies in addition to the points listed under "Electrical components with a housing":

- Any persons handling electrical components or devices with installed electrical components must be grounded.
- Components may only be touched on their narrow sides or front plate.
- Components should always be stored in a suitable medium (ESD packaging, conductive foam, etc.).
Information: Metallic surfaces are not suitable storage surfaces!
- Components should not be subjected to electrostatic discharge (e.g. through the use of charged plastics).
- Ensure a minimum distance of 10 cm from monitors and TV sets.
- Measurement devices and equipment must be grounded.
- Measurement probes on potential-free measurement devices must be discharged on sufficiently grounded surfaces before taking measurements.

Individual components

- ESD protective measures for individual components are thoroughly integrated at B&R (conductive floors, footwear, arm bands, etc.).
- These increased ESD protective measures for individual components are not necessary for customers handling B&R products.

2.4 Transport and storage

During transport and storage, devices must be protected against undue stress (mechanical loads, temperature, humidity, aggressive atmospheres, etc.).

Devices contain components sensitive to electrostatic charges that can be damaged by inappropriate handling. It is therefore necessary to provide the required protective measures against electrostatic discharge when installing or removing these devices (see "Protection against electrostatic discharge" on page 4).

2.5 Installation

- Installation must be performed according to this documentation using suitable equipment and tools.
- Devices may only be installed by qualified personnel without voltage applied.
- General safety guidelines and national accident prevention regulations must be observed.
- Electrical installation must be carried out according to applicable guidelines (e.g. line cross sections, fuses, protective ground connections).
- Take the necessary steps to protect against electrostatic discharges ().

2.6 Operation

2.6.1 Protection against touching electrical parts

To operate programmable logic controllers, operating/monitoring devices or uninterruptible power supplies, it is necessary for certain parts to carry dangerous voltage levels over 42 VDC. Touching one of these parts can result in a life-threatening electric shock. This could lead to death, severe injury or damage to equipment.

Before turning on the programmable logic controller, operating/monitoring devices or the uninterruptible power supply, the housing must be properly grounded (PE rail). Ground connections must be established even when testing or operating operating/monitoring devices or the uninterruptible power supply for a short time!

Before turning the device on, all parts that carry voltage must be securely covered. During operation, all covers must remain closed.

2.6.2 Environmental conditions - Dust, humidity, aggressive gases

The use of operating/monitoring devices (e.g. industrial PCs, Power Panels, Mobile Panels, etc.) and uninterruptible power supplies in very dusty environments should be avoided. Dust collection on the devices can affect functionality and may prevent sufficient cooling, especially in systems with active cooling systems (fans).

The presence of aggressive gases can also lead to malfunctions. When combined with high temperature and humidity, aggressive gases – e.g. with sulfur, nitrogen and chlorine components – can induce chemical reactions that can damage electronic components very quickly. Signs of the presence of aggressive gases are blackened copper surfaces and cable ends on existing equipment.

For operation in dusty or humid conditions, correctly installed (e.g. cutout installations) operating/monitoring devices like the Automation Panel or Power Panel are protected on the front. The back of all devices must be protected from dust and humidity and cleaned at suitable intervals.

2.6.3 Viruses and dangerous programs

This system is subject to potential risk each time data is exchanged or software is installed from a data medium (e.g. diskette, CD-ROM, USB flash drive, etc.), a network connection or the Internet. The user is responsible for assessing these dangers, implementing preventive measures such as virus protection programs, firewalls, etc. and making sure that software is only obtained from trusted sources.

2.7 Organization of safety notices

Safety notices in this manual are organized as follows:

Safety notice	Description
Danger!	Disregarding these safety guidelines and notices can be life-threatening.
Caution!	Disregarding these safety guidelines and notices can result in severe injury or substantial damage to equipment.
Warning!	Disregarding these safety guidelines and notices can result in injury or damage to equipment.
Information:	This information is important for preventing errors.

Table 2: Organization of safety notices

Chapter 2 • Power Panel C-Series

1 System features

B&R has added the new Power Panel C-Series to its Power Panel family. The Power Panel C70 achieves cycle times as fast as 1 ms. In addition to POWERLINK, Ethernet, USB and X2X Link connections, the devices are also available with an option board, providing CAN, RS232 and RS485 interfaces.



Figure 1: C-Series

1.1 Compact solution

Power Panels have an extremely compact design, minimal installation depth and an intelligent cable outlet arrangement, making them easy-to-mount space savers. And because they have no hard disks, fans or batteries, they are also maintenance-free. The panel front provides IP65 protection, which makes these devices extremely well-suited for harsh industrial environments.

1.2 Simple programming

Full integration of the HMI application in the Automation Studio automation software goes without saying. The same is true for programming in all of the IEC languages offered by B&R as well as Automation Basic and ANSI C.

1.3 Power Panel C70

The Power Panel C70 is an HMI terminal with a built-in PLC. The Intel Atom processor provides enough performance to allow applications to achieve cycle times down to 1 ms. Automation Runtime, which provides up to eight task classes, is the basis for this.



Figure 2: Power Panel C70

1.4 Flexibility

The Power Panel C-Series is available in three different display sizes.

- 5.7" display
- 7.0" display
- 10.1" display

A touch button is integrated in the panel overlay at the lower right corner of the display. This element can be incorporated as an elegant feature of the HMI application for quick navigation or easy access to the home screen or help system.

The option to choose between portrait and landscape format adds even more flexibility to the machine layout. It is easy to switch between panel models depending on machine requirements. When it comes to color, users can select between two pinstripe options: anthracite gray or aluminum white.

Regardless of model, size and color, what all the devices have in common are a shallow installation depth and a minimized border width. Yet, even with the reduced dimensions, no compromises were made with regard to mounting stability or seal integrity.

2 C-Series

2.1 Selecting a Power Panel







Configuration		
<p>Display size</p> <p>The Power Panel C-Series is available in three different display sizes:</p> <p>5.7" variant 7.0" variant 10.1" variant</p>	<p>5.7"</p>  <p>4PPC70.057x-2xx</p>	<p>7"</p>  <p>4PPC70.070x-2xx</p>
<p>Resolution</p> <p>The option to choose between portrait and landscape format adds even more flexibility to the machine layout.</p>	<p>Landscape</p>  <p>4PPC70.057L-2xx 4PPC70.070L-2xx 4PPC70.101G-2xx</p>	<p>Portrait</p>  <p>4PPC70.057L-2xx 4PPC70.070M-2xx 4PPC70.101N-2xx</p>
<p>Interfaces on option board</p> <p>Adding an option board gives the Power Panel two additional interfaces.</p>	<p>4PPC70.xxxx-20x - No option board 4PPC70.xxxx-22x - 1x RS232, 1x CAN bus</p>	<p>4PPC70.xxxx-21x - 2x CAN bus 4PPC70.xxxx-23x - 1x RS485, 1x CAN bus</p>
<p>Panel overlay</p> <p>The pinstripe design is available in aluminum white or anthracite gray.</p>	<p>Aluminum white pinstripe</p> 	<p>Anthracite gray pinstripe</p> 
	<p>4PPC70.0573-20W 4PPC70.0702-20W 4PPC70.101G-20W 4PPC70.057L-20W 4PPC70.070M-20W 4PPC70.101N-20W 4PPC70.0573-21W 4PPC70.0702-21W 4PPC70.101G-21W 4PPC70.057L-21W 4PPC70.070M-21W 4PPC70.101N-21W 4PPC70.0573-22W 4PPC70.0702-22W 4PPC70.101G-22W 4PPC70.057L-22W 4PPC70.070M-22W 4PPC70.101N-22W 4PPC70.0573-23W 4PPC70.0702-23W 4PPC70.101G-23W 4PPC70.057L-23W 4PPC70.070M-23W 4PPC70.101N-23W</p>	<p>4PPC70.0573-20B 4PPC70.0702-20B 4PPC70.101G-20B 4PPC70.057L-20B 4PPC70.070M-20B 4PPC70.101N-20B 4PPC70.0573-21B 4PPC70.0702-21B 4PPC70.101G-21B 4PPC70.057L-21B 4PPC70.070M-21B 4PPC70.101N-21B 4PPC70.0573-22B 4PPC70.0702-22B 4PPC70.101G-22B 4PPC70.057L-22B 4PPC70.070M-22B 4PPC70.101N-22B 4PPC70.0573-23B 4PPC70.0702-23B 4PPC70.101G-23B 4PPC70.057L-23B 4PPC70.070M-23B 4PPC70.101N-23B</p>

Figure 4: Selecting a Power Panel

2.2 General technical data

Name	Description
Processor	Intel E620T 333 MHz
Memory	256 MB DDRAM
Interfaces	1 X2X Link interface 1 POWERLINK interface 1 Ethernet interface 10BASE-T/100BASE-TX, 2 USB 2.0 ports
Other	IP65 protection (front side) Temperature range from 0 to 50°C Fanless 24 VDC power supply -15% / +20%

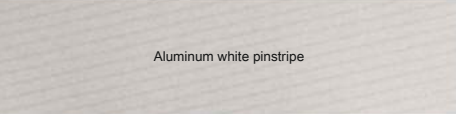
Table 3: Power Panel C-Series - General technical data

2.3 Overview

2.3.1 Overview - 4PPC70.057x



Model number	4PPC70.0573-2xW	4PPC70.0573-2xB	4PPC70.057L-2xW	4PPC70.057L-2xB
Figure				
Display	Color TFT			
Resolution	VGA			
Display size	5.7"			
Touch screen	Analog resistive			
Format	Landscape		Portrait	
Color	Aluminum white	Anthracite	Aluminum white	Anthracite
Page	13			

Table 4: Overview - 4PPC70.057x

2.3.2 Overview - 4PPC70.070x



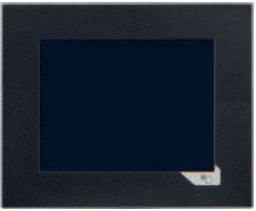

Model number	4PPC70.0702-2xW	4PPC70.0702-2xB	4PPC70.070M-2xW	4PPC70.070M-2xB
Figure				
Display	Color TFT			
Resolution	WVGA			
Display size	7.0"			
Touch screen	Analog resistive			
Format	Landscape		Portrait	
Color	Aluminum white	Anthracite	Aluminum white	Anthracite
Page	29			

Table 5: Overview - 4PPC70.070x

2.3.3 Overview - 4PPC70.101x



Model number	4PPC70.101G-2xW	4PPC70.101G-2xB	4PPC70.101N-2xW	4PPC70.101N-2xB
Figure				

Table 6: Overview - 4PPC70.101x

Model number	4PPC70.101G-2xW	4PPC70.101G-2xB	4PPC70.101N-2xW	4PPC70.101N-2xB
Display	Color TFT			
Resolution	WSVGA			
Display size	10.1"			
Touch screen	Analog resistive			
Format	Landscape		Portrait	
Color	Aluminum white	Anthracite	Aluminum white	Anthracite
Page	45			

Table 6: Overview - 4PPC70.101x

2.3.4 Interfaces

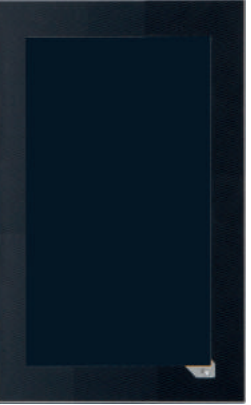
Model number	4PPC70.xxxx-20x	4PPC70.xxxx-21x	4PPC70.xxxx-22x	4PPC70.xxxx-23x
Figure				
Ethernet interface 10/100BASE-TX			1	
POWERLINK interface			1	
X2X Link interface			1	
USB 2.0 port			2	
2 CAN bus		1		
1 RS232, 1 CAN bus			1	
1 RS485, 1 CAN-Bus				1

Table 7: Interfaces

2.4 4PPC70.xxxx-2xx

2.4.1 4PPC70.057x-2xx

2.4.1.1 4PPC70.057x-2xx - Order data

2.4.1.1.1 4PPC70.057x-20x - Order data

Model number	Short description	Figure
	C70	
4PPC70.0573-20W	Power Panel C70, 5.7", analog resistive touch screen, Intel ATOM 333 MHz comp., 256 MB DDRAM, 32 kB FRAM, 2 GB flash drive onboard, 1 X2X Link interface, 1 POWERLINK interface, 1 Ethernet interface 10BASE-T/100BASE-TX, 2 USB 2.0 interfaces, basic device without option board, landscape format, aluminum white pinstripe	
4PPC70.0573-20B	Power Panel C70, 5.7", analog resistive touch screen, Intel ATOM 333 MHz comp., 256 MB DDRAM, 32 kB FRAM, 2 GB flash drive onboard, 1 X2X Link interface, 1 POWERLINK interface, 1 Ethernet interface 10BASE-T/100BASE-TX, 2 USB 2.0 interfaces, basic device without option board, landscape format, anthracite gray pinstripe	
4PPC70.057L-20W	Power Panel C70, 5.7", analog resistive touch screen, Intel ATOM 333 MHz comp., 256 MB DDRAM, 32 kB FRAM, 2 GB flash drive onboard, 1 X2X Link interface, 1 POWERLINK interface, 1 Ethernet interface 10BASE-T/100BASE-TX, 2 USB 2.0 interfaces, basic device without option board, portrait format, aluminum white pinstripe	
4PPC70.057L-20B	Power Panel C70, 5.7", analog resistive touch screen, Intel ATOM 333 MHz comp., 256 MB DDRAM, 32 kB FRAM, 2 GB flash drive onboard, 1 X2X Link interface, 1 POWERLINK interface, 1 Ethernet interface 10BASE-T/100BASE-TX, 2 USB 2.0 interfaces, basic device without option board, portrait format, anthracite gray pinstripe	
	Required accessories	
	Terminal blocks	
0TB5104.2110-01	Accessory terminal block, 4-pin (2.5), cage clamp, 0.5 mm ²	
0TB6102.2010-01	Accessory terminal block, 2-pin (3.81), screw clamp 1.5 mm ²	
0TB6102.2110-01	Accessory terminal block, 2-pin (3.81), cage clamp, 1.5 mm ²	
	USB accessories	
5MMUSB.2048-01	USB 2.0 flash drive, 2048 MB, B&R	
5MMUSB.4096-01	USB 2.0 flash drive, 4096 MB, B&R	

Table 8: 4PPC70.0573-20W, 4PPC70.0573-20B, 4PPC70.057L-20W, 4PPC70.057L-20B - Order data

2.4.1.1.2 4PPC70.057x-21x - Order data

Model number	Short description	Figure
	C70	
4PPC70.0573-21W	Power Panel C70, 5.7", analog resistive touch screen, Intel ATOM 333 MHz comp., 256 MB DDRAM, 32 kB FRAM, 2 GB flash drive onboard, 1 X2X Link interface, 1 POWERLINK interface, 1 Ethernet interface 10BASE-T/100BASE-TX, 2 USB 2.0 interfaces, basic device with option board: 2x CAN bus, landscape format, aluminum white pinstripe	
4PPC70.0573-21B	Power Panel C70, 5.7", analog resistive touch screen, Intel ATOM 333 MHz comp., 256 MB DDRAM, 32 kB FRAM, 2 GB flash drive onboard, 1 X2X Link interface, 1 POWERLINK interface, 1 Ethernet interface 10BASE-T/100BASE-TX, 2 USB 2.0 interfaces, basic device with option board: 2x CAN bus, landscape format, anthracite gray pinstripe	
4PPC70.057L-21W	Power Panel C70, 5.7", analog resistive touch screen, Intel ATOM 333 MHz comp., 256 MB DDRAM, 32 kB FRAM, 2 GB flash drive onboard, 1 X2X Link interface, 1 POWERLINK interface, 1 Ethernet interface 10BASE-T/100BASE-TX, 2 USB 2.0 interfaces, basic device with option board: 2x CAN bus, portrait format, aluminum white pinstripe	
4PPC70.057L-21B	Power Panel C70, 5.7", analog resistive touch screen, Intel ATOM 333 MHz comp., 256 MB DDRAM, 32 kB FRAM, 2 GB flash drive onboard, 1 X2X Link interface, 1 POWERLINK interface, 1 Ethernet interface 10BASE-T/100BASE-TX, 2 USB 2.0 interfaces, basic device with option board: 2x CAN bus, portrait format, anthracite gray pinstripe	
	Required accessories	
	Terminal blocks	
0TB5104.2110-01	Accessory terminal block, 4-pin (2.5), cage clamp, 0.5 mm ²	
0TB5106.2110-01	Accessory terminal block, 6-pin (2.5), cage clamp, 0.5 mm ²	
0TB6102.2010-01	Accessory terminal block, 2-pin (3.81), screw clamp 1.5 mm ²	
0TB6102.2110-01	Accessory terminal block, 2-pin (3.81), cage clamp, 1.5 mm ²	
	USB accessories	
5MMUSB.2048-01	USB 2.0 flash drive, 2048 MB, B&R	
5MMUSB.4096-01	USB 2.0 flash drive, 4096 MB, B&R	

Table 9: 4PPC70.0573-21W, 4PPC70.0573-21B, 4PPC70.057L-21W, 4PPC70.057L-21B - Order data

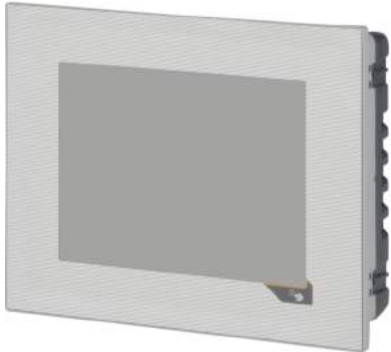
2.4.1.1.3 4PPC70.057x-22x - Order data

Model number	Short description	Figure
	C70	
4PPC70.0573-22W	Power Panel C70, 5.7", analog resistive touch screen, Intel ATOM 333 MHz comp., 256 MB DDRAM, 32 kB FRAM, 2 GB flash drive onboard, 1 X2X Link interface, 1 POWERLINK interface, 1 Ethernet interface 10BASE-T/100BASE-TX, 2 USB 2.0 interfaces, basic device with option board: 1x CAN bus, 1x RS232, landscape format, aluminum white pinstripe	
4PPC70.0573-22B	Power Panel C70, 5.7", analog resistive touch screen, Intel ATOM 333 MHz comp., 256 MB DDRAM, 32 kB FRAM, 2 GB flash drive onboard, 1 X2X Link interface, 1 POWERLINK interface, 1 Ethernet interface 10BASE-T/100BASE-TX, 2 USB 2.0 interfaces, basic device with option board: 1x CAN bus, 1x RS232, landscape format, anthracite gray pinstripe	
4PPC70.057L-22W	Power Panel C70, 5.7", analog resistive touch screen, Intel ATOM 333 MHz comp., 256 MB DDRAM, 32 kB FRAM, 2 GB flash drive onboard, 1 X2X Link interface, 1 POWERLINK interface, 1 Ethernet interface 10BASE-T/100BASE-TX, 2 USB 2.0 interfaces, basic device with option board: 1x CAN bus, 1x RS232, portrait format, aluminum white pinstripe	
4PPC70.057L-22B	Power Panel C70, 5.7", analog resistive touch screen, Intel ATOM 333 MHz comp., 256 MB DDRAM, 32 kB FRAM, 2 GB flash drive onboard, 1 X2X Link interface, 1 POWERLINK interface, 1 Ethernet interface 10BASE-T/100BASE-TX, 2 USB 2.0 interfaces, basic device with option board: 1x CAN bus, 1x RS232, portrait format, anthracite gray pinstripe	
	Required accessories	
	Terminal blocks	
0TB5104.2110-01	Accessory terminal block, 4-pin (2.5), cage clamp, 0.5 mm ²	
0TB5106.2110-01	Accessory terminal block, 6-pin (2.5), cage clamp, 0.5 mm ²	
0TB6102.2010-01	Accessory terminal block, 2-pin (3.81), screw clamp 1.5 mm ²	
0TB6102.2110-01	Accessory terminal block, 2-pin (3.81), cage clamp, 1.5 mm ²	
	USB accessories	
5MMUSB.2048-01	USB 2.0 flash drive, 2048 MB, B&R	
5MMUSB.4096-01	USB 2.0 flash drive, 4096 MB, B&R	

Table 10: 4PPC70.0573-22W, 4PPC70.0573-22B, 4PPC70.057L-22W, 4PPC70.057L-22B - Order data

2.4.1.1.4 4PPC70.057x-23x - Order data

Model number	Short description	Figure
	C70	
4PPC70.0573-23W	Power Panel C70, 5.7", analog resistive touch screen, Intel ATOM 333 MHz comp., 256 MB DDRAM, 32 kB FRAM, 2 GB flash drive onboard, 1 X2X Link interface, 1 POWERLINK interface, 1 Ethernet interface 10BASE-T/100BASE-TX, 2 USB 2.0 interfaces, basic device with option board: 1x CAN bus, 1x RS485, landscape format, aluminum white pinstripe	
4PPC70.0573-23B	Power Panel C70, 5.7", analog resistive touch screen, Intel ATOM 333 MHz comp., 256 MB DDRAM, 32 kB FRAM, 2 GB flash drive onboard, 1 X2X Link interface, 1 POWERLINK interface, 1 Ethernet interface 10BASE-T/100BASE-TX, 2 USB 2.0 interfaces, basic device with option board: 1x CAN bus, 1x RS485, landscape format, anthracite gray pinstripe	
4PPC70.057L-23W	Power Panel C70, 5.7", analog resistive touch screen, Intel ATOM 333 MHz comp., 256 MB DDRAM, 32 kB FRAM, 2 GB flash drive onboard, 1 X2X Link interface, 1 POWERLINK interface, 1 Ethernet interface 10BASE-T/100BASE-TX, 2 USB 2.0 interfaces, basic device with option board: 1x CAN bus, 1x RS485, portrait format, aluminum white pinstripe	
4PPC70.057L-23B	Power Panel C70, 5.7", analog resistive touch screen, Intel ATOM 333 MHz comp., 256 MB DDRAM, 32 kB FRAM, 2 GB flash drive onboard, 1 X2X Link interface, 1 POWERLINK interface, 1 Ethernet interface 10BASE-T/100BASE-TX, 2 USB 2.0 interfaces, basic device with option board: 1x CAN bus, 1x RS485, portrait format, anthracite gray pinstripe	
	Required accessories	
	Terminal blocks	
0TB5104.2110-01	Accessory terminal block, 4-pin (2.5), cage clamp, 0.5 mm ²	
0TB5106.2110-01	Accessory terminal block, 6-pin (2.5), cage clamp, 0.5 mm ²	
0TB6102.2010-01	Accessory terminal block, 2-pin (3.81), screw clamp 1.5 mm ²	
0TB6102.2110-01	Accessory terminal block, 2-pin (3.81), cage clamp, 1.5 mm ²	
	USB accessories	
5MMUSB.2048-01	USB 2.0 flash drive, 2048 MB, B&R	
5MMUSB.4096-01	USB 2.0 flash drive, 4096 MB, B&R	

Table 11: 4PPC70.0573-23W, 4PPC70.0573-23B, 4PPC70.057L-23W, 4PPC70.057L-23B - Order data

2.4.1.2 Technical data 4PPC70.057x-2xx

2.4.1.2.1 Technical data 4PPC70.057x-20x

Product ID	4PPC70.0573-20W	4PPC70.0573-20B	4PPC70.057L-20W	4PPC70.057L-20B
General information				
Cooling	Fanless			
LEDs	Supply voltage OK, operating status, module status, Ethernet, POWERLINK			
B&R ID code	0xE55D	0xE4B2	0xE561	0xE565
System requirements				
Automation Studio	4.1.4.375 or higher			
Automation Runtime	K4.08 or higher			
Support of X20SLX modules	B4 or higher			
LEDs				
Quantity	4			
Power button	No			
Reset button	Yes			
Controller redundancy				
Master capability	No			
Buzzer	Yes			
ACOPOS capability	Yes			
Visual Components support	Yes			
Certification				
CE	Yes			
GOST-R	Yes			
Controller				
Boot loader	Automation Runtime AR 4.08			
CompactFlash slot	0			
DRAM	256 MB			
Real-time clock ¹⁾	Yes, resolution 1 s			
FPU	Yes			
Processor				
Type	Intel E620T			
Clock frequency	333 MHz			
L1 cache				
Data code	24 kB			
Program code	32 kB			
L2 cache	-			
Cooling	Passive			
Mode/Node switches	No			
Remanent variables	32 kB			
Typical shortest task class cycle time	1 ms ²⁾			
Shortest task class cycle time	0.4 ms			
Typical instruction cycle time	0.01 µs			
Application memory				
Type	2 GB eMMC flash memory			
Data retention	10 years			
Writable data amount				
Guaranteed	40 TB			
Results for 5 years	21.9 GB/day			
Guaranteed clear/write cycles	20,000			
Error correction coding (ECC)	Yes			
Interfaces				
IF1 interface				
Fieldbus	POWERLINK managing or controlled node			
Type	Type 4 ³⁾			
Design	1x RJ45 shielded			
Cable length	Max. 100 m between 2 nodes (segment length)			
Max. transfer rate	100 Mbit/s			
Transmission				
Physical interfaces	100BASE-TX			
Half-duplex	Yes			
Full-duplex	No			
Autonegotiation	Yes			
Auto-MDI / MDIX	Yes			

Table 12: 4PPC70.0573-20W, 4PPC70.0573-20B, 4PPC70.057L-20W, 4PPC70.057L-20B - Technical data

Product ID	4PPC70.0573-20W	4PPC70.0573-20B	4PPC70.057L-20W	4PPC70.057L-20B
IF2 interface				
Type	Ethernet			
Design	1x RJ45 shielded			
Cable length	Max. 100 m between 2 nodes (segment length)			
Max. transfer rate	10/100 Mbit/s			
Transmission				
Physical interfaces	10BASE-T/100BASE-TX			
Half-duplex	Yes			
Full-duplex	Yes			
Autonegotiation	Yes			
Auto-MDI / MDIX	Yes			
IF3 interface				
Type	USB 2.0			
Design	Type A			
Current load	0.49 A			
IF4 interface				
Type	USB 2.0			
Design	Type A			
Current load	0.10 A			
IF5 interface				
Type	X2X Link master			
Display				
Type	Color TFT			
Display size	5.7"			
Colors	262,000			
Resolution	VGA, 640 x 480 pixels		VGA, 480 x 640 pixels	
Contrast	Typ. 850:1			
Viewing angles				
Horizontal	Direction R / Direction L = typ. 80°			
Vertical	Direction U / Direction D = typ. 80°			
Backlight				
Type	LED			
Brightness	Typ. 400 cd/m ²			
Half-brightness time ⁴⁾	50,000 h			
Touch screen				
Type	AMT			
Technology	Analog resistive			
Controller	B&R, serial, 12-bit			
Transmittance	80% ±3%			
Screen rotation	Yes, using VC			
Electrical characteristics				
Nominal voltage	24 VDC -15% / +20%			
Max. power consumption ⁵⁾	14.4 W			
Reverse polarity protection	Yes			
Electrical isolation	No			
Operating conditions				
Installation at elevations above sea level				
0 to 2000 m	No limitations			
>2000 m	Reduction of ambient temperature by 0.5°C per 100 m			
EN 60529 protection	Back: IP20 Front: IP65			
Environmental conditions				
Temperature				
Operation				
Horizontal installation	0 to 50°C			
Vertical installation	0 to 50°C			
Storage	-20 to 60°C			
Transport	-20 to 60°C			
Relative humidity				
Operation	See humidity diagram			
Storage	See humidity diagram			
Transport	See humidity diagram			
Mechanical characteristics				
Note	Order 1x 0TB5104.2110-01, 1x 0TB6102.2010-01 and 1x 0TB6102.2110-01 terminal block separately			
Front				
Design	Aluminum white pinstripe	Anthracite gray pinstripe	Aluminum white pinstripe	Anthracite gray pinstripe
Dimensions				
Width	172 mm		140 mm	
Height	140 mm		172 mm	
Depth	51 mm			

Table 12: 4PPC70.0573-20W, 4PPC70.0573-20B, 4PPC70.057L-20W, 4PPC70.057L-20B - Technical data

- 1) The real-time clock is buffered for approx. 1000 hours @ 25°C by a gold foil capacitor. The gold foil capacitor is completely charged after 18 continuous hours of operation.
- 2) Shortest cycle time that is suitable for average applications. In certain cases, it is also possible to use shorter cycle times. The limit for the setting is specified in the entry for the shortest task class cycle time.

- 3) See the POWERLINK help system under "General information, Hardware - IF/LS".
- 4) At an ambient temperature of 25°C. Reducing the brightness by 50% can typically result in an approximately 50% increase in the half-brightness time.
- 5) Remote stations connected via X2X Link, CAN bus, POWERLINK and Ethernet. Both USB interfaces are used.

2.4.1.2.2 Technical data 4PPC70.057x-21x

Product ID	4PPC70.0573-21W	4PPC70.0573-21B	4PPC70.057L-21W	4PPC70.057L-21B
General information				
Cooling	Fanless			
LEDs	Supply voltage OK, operating status, module status, Ethernet, POWERLINK, CAN Rx/Tx			
B&R ID code	0xE55E	0xE4B3	0xE562	0xE566
System requirements	4.1.4.375 or higher			
Automation Studio	K4.08 or higher			
Automation Runtime	B4 or higher			
Support of X20SLX modules				
LEDs				
Quantity	9			
Power button	No			
Reset button	Yes			
Controller redundancy				
Master capability	No			
Buzzer	Yes			
ACOPOS capability	Yes			
Visual Components support	Yes			
Certification				
CE	Yes			
GOST-R	Yes			
Controller				
Boot loader	Automation Runtime AR 4.08			
CompactFlash slot	0			
DRAM	256 MB			
Real-time clock ¹⁾	Yes, resolution 1 s			
FPU	Yes			
Processor				
Type	Intel E620T			
Clock frequency	333 MHz			
L1 cache				
Data code	24 kB			
Program code	32 kB			
L2 cache	-			
Cooling	Passive			
Mode/Node switches	No			
Remanent variables	32 kB			
Typical shortest task class cycle time	1 ms ²⁾			
Shortest task class cycle time	0.4 ms			
Typical instruction cycle time	0.01 µs			
Application memory				
Type	2 GB eMMC flash memory			
Data retention	10 years			
Writable data amount				
Guaranteed	40 TB			
Results for 5 years	21.9 GB/day			
Guaranteed clear/write cycles	20,000			
Error correction coding (ECC)	Yes			
Interfaces				
IF1 interface				
Fieldbus	POWERLINK managing or controlled node			
Type	Type 4 ³⁾			
Design	1x RJ45 shielded			
Cable length	Max. 100 m between 2 nodes (segment length)			
Max. transfer rate	100 Mbit/s			
Transmission				
Physical interfaces	100BASE-TX			
Half-duplex	Yes			
Full-duplex	No			
Autonegotiation	Yes			
Auto-MDI / MDIX	Yes			
IF2 interface				
Type	Ethernet			
Design	1x RJ45 shielded			
Cable length	Max. 100 m between 2 nodes (segment length)			
Max. transfer rate	10/100 Mbit/s			
Transmission				
Physical interfaces	10BASE-T/100BASE-TX			
Half-duplex	Yes			
Full-duplex	Yes			
Autonegotiation	Yes			
Auto-MDI / MDIX	Yes			

Table 13: 4PPC70.0573-21W, 4PPC70.0573-21B, 4PPC70.057L-21W, 4PPC70.057L-21B - Technical data

Product ID	4PPC70.0573-21W	4PPC70.0573-21B	4PPC70.057L-21W	4PPC70.057L-21B
IF3 interface				
Type	USB 2.0			
Design	Type A			
Current load	0.49 A			
IF4 interface				
Type	USB 2.0			
Design	Type A			
Current load	0.10 A			
IF5 interface				
Type	X2X Link master			
IF6 interface				
Type	CAN bus			
Design	3 pins of the 6-pin multipoint connector			
Max. distance	1000 m			
Max. transfer rate				
Bus length ≤25 m	1 Mbit/s			
Bus length ≤60 m	500 kbit/s			
Bus length ≤200 m	250 kbit/s			
Bus length ≤1000 m	50 kbit/s			
IF7 interface				
Type	CAN bus			
Design	3 pins of the 6-pin multipoint connector			
Max. distance	1000 m			
Max. transfer rate				
Bus length ≤25 m	1 Mbit/s			
Bus length ≤60 m	500 kbit/s			
Bus length ≤200 m	250 kbit/s			
Bus length ≤1000 m	50 kbit/s			
Display				
Type	Color TFT			
Display size	5.7"			
Colors	262,000			
Resolution	VGA, 640 x 480 pixels		VGA, 480 x 640 pixels	
Contrast	Typ. 850:1			
Viewing angles				
Horizontal	Direction R / Direction L = typ. 80°			
Vertical	Direction U / Direction D = typ. 80°			
Backlight				
Type	LED			
Brightness	Typ. 400 cd/m ²			
Half-brightness time ⁴⁾	50,000 h			
Touch screen				
Type	AMT			
Technology	Analog resistive			
Controller	B&R, serial, 12-bit			
Transmittance	80% ±3%			
Screen rotation	Yes, using VC			
Electrical characteristics				
Nominal voltage	24 VDC -15% / +20%			
Max. power consumption ⁵⁾	14.4 W			
Reverse polarity protection	Yes			
Electrical isolation	No			
Operating conditions				
Installation at elevations above sea level				
0 to 2000 m	No limitations			
>2000 m	Reduction of ambient temperature by 0.5°C per 100 m			
EN 60529 protection	Back: IP20 Front: IP65			
Environmental conditions				
Temperature				
Operation				
Horizontal installation	0 to 50°C			
Vertical installation	0 to 50°C			
Storage	-20 to 60°C			
Transport	-20 to 60°C			
Relative humidity				
Operation	See humidity diagram			
Storage	See humidity diagram			
Transport	See humidity diagram			
Mechanical characteristics				
Note	Order 1x 0TB5104.2110-01, 1x 0TB5106.2110-01, 1x 0TB6102.2010-01 and 1x 0TB6102.2110-01 terminal block separately			
Front				
Design	Aluminum white pinstripe	Anthracite gray pinstripe	Aluminum white pinstripe	Anthracite gray pinstripe

Table 13: 4PPC70.0573-21W, 4PPC70.0573-21B, 4PPC70.057L-21W, 4PPC70.057L-21B - Technical data

Product ID	4PPC70.0573-21W	4PPC70.0573-21B	4PPC70.057L-21W	4PPC70.057L-21B
Dimensions				
Width	172 mm			140 mm
Height	140 mm			172 mm
Depth			51 mm	

Table 13: 4PPC70.0573-21W, 4PPC70.0573-21B, 4PPC70.057L-21W, 4PPC70.057L-21B - Technical data

- 1) The real-time clock is buffered for approx. 1000 hours @ 25°C by a gold foil capacitor. The gold foil capacitor is completely charged after 18 continuous hours of operation.
- 2) Shortest cycle time that is suitable for average applications. In certain cases, it is also possible to use shorter cycle times. The limit for the setting is specified in the entry for the shortest task class cycle time.
- 3) See the POWERLINK help system under "General information, Hardware - IF/LS".
- 4) At an ambient temperature of 25°C. Reducing the brightness by 50% can typically result in an approximately 50% increase in the half-brightness time.
- 5) Remote stations connected via X2X Link, CAN bus, POWERLINK and Ethernet. Both USB interfaces are used.

2.4.1.2.3 Technical data 4PPC70.057x-22x

Product ID	4PPC70.0573-22W	4PPC70.0573-22B	4PPC70.057L-22W	4PPC70.057L-22B
General information				
Cooling	Fanless			
LEDs	Supply voltage OK, operating status, module status, Ethernet, POWERLINK, CAN Rx/Tx, RS232 Rx/Tx			
B&R ID code	0xE55F	0xE4B4	0xE563	0xE567
System requirements				
Automation Studio	4.1.4.375 or higher			
Automation Runtime	K4.08 or higher			
Support of X20SLX modules	B4 or higher			
LEDs				
Quantity	9			
Power button	No			
Reset button	Yes			
Controller redundancy				
Master capability	No			
Buzzer	Yes			
ACOPOS capability	Yes			
Visual Components support	Yes			
Certification				
CE	Yes			
GOST-R	Yes			
Controller				
Boot loader	Automation Runtime AR 4.08			
CompactFlash slot	0			
DRAM	256 MB			
Real-time clock ¹⁾	Yes, resolution 1 s			
FPU	Yes			
Processor				
Type	Intel E620T			
Clock frequency	333 MHz			
L1 cache				
Data code	24 kB			
Program code	32 kB			
L2 cache	-			
Cooling	Passive			
Mode/Node switches	No			
Remanent variables	32 kB			
Typical shortest task class cycle time	1 ms ²⁾			
Shortest task class cycle time	0.4 ms			
Typical instruction cycle time	0.01 µs			
Application memory				
Type	2 GB eMMC flash memory			
Data retention	10 years			
Writable data amount				
Guaranteed	40 TB			
Results for 5 years	21.9 GB/day			
Guaranteed clear/write cycles	20,000			
Error correction coding (ECC)	Yes			
Interfaces				
IF1 interface				
Fieldbus	POWERLINK managing or controlled node			
Type	Type 4 ³⁾			
Design	1x RJ45 shielded			
Cable length	Max. 100 m between 2 nodes (segment length)			
Max. transfer rate	100 Mbit/s			
Transmission				
Physical interfaces	100BASE-TX			
Half-duplex	Yes			
Full-duplex	No			
Autonegotiation	Yes			
Auto-MDI / MDIX	Yes			
IF2 interface				
Type	Ethernet			
Design	1x RJ45 shielded			
Cable length	Max. 100 m between 2 nodes (segment length)			
Max. transfer rate	10/100 Mbit/s			
Transmission				
Physical interfaces	10BASE-T/100BASE-TX			
Half-duplex	Yes			
Full-duplex	Yes			
Autonegotiation	Yes			
Auto-MDI / MDIX	Yes			

Table 14: 4PPC70.0573-22W, 4PPC70.0573-22B, 4PPC70.057L-22W, 4PPC70.057L-22B - Technical data

Product ID	4PPC70.0573-22W	4PPC70.0573-22B	4PPC70.057L-22W	4PPC70.057L-22B
IF3 interface				
Type	USB 2.0			
Design	Type A			
Current load	0.49 A			
IF4 interface				
Type	USB 2.0			
Design	Type A			
Current load	0.10 A			
IF5 interface				
Type	X2X Link master			
IF6 interface				
Type	CAN bus			
Design	3 pins of the 6-pin multipoint connector			
Max. distance	1000 m			
Max. transfer rate				
Bus length ≤25 m	1 Mbit/s			
Bus length ≤60 m	500 kbit/s			
Bus length ≤200 m	250 kbit/s			
Bus length ≤1000 m	50 kbit/s			
IF8 interface				
Type	RS232			
Design	3 pins of the 6-pin multipoint connector			
Max. distance	900 m			
Transfer rate	Max. 1152 kbit/s			
Display				
Type	Color TFT			
Display size	5.7"			
Colors	262,000			
Resolution	VGA, 640 x 480 pixels		VGA, 480 x 640 pixels	
Contrast	Typ. 850:1			
Viewing angles				
Horizontal	Direction R / Direction L = typ. 80°			
Vertical	Direction U / Direction D = typ. 80°			
Backlight				
Type	LED			
Brightness	Typ. 400 cd/m ²			
Half-brightness time ⁴⁾	50,000 h			
Touch screen				
Type	AMT			
Technology	Analog resistive			
Controller	B&R, serial, 12-bit			
Transmittance	80% ±3%			
Screen rotation	Yes, using VC			
Electrical characteristics				
Nominal voltage	24 VDC -15% / +20%			
Max. power consumption ⁵⁾	14.4 W			
Reverse polarity protection	Yes			
Electrical isolation	No			
Operating conditions				
Installation at elevations above sea level				
0 to 2000 m	No limitations			
>2000 m	Reduction of ambient temperature by 0.5°C per 100 m			
EN 60529 protection	Back: IP20 Front: IP65			
Environmental conditions				
Temperature				
Operation				
Horizontal installation	0 to 50°C			
Vertical installation	0 to 50°C			
Storage	-20 to 60°C			
Transport	-20 to 60°C			
Relative humidity				
Operation	See humidity diagram			
Storage	See humidity diagram			
Transport	See humidity diagram			
Mechanical characteristics				
Note	Order 1x 0TB5104.2110-01, 1x 0TB5106.2110-01, 1x 0TB6102.2010-01 and 1x 0TB6102.2110-01 terminal block separately			
Front				
Design	Aluminum white pinstripe	Anthracite gray pinstripe	Aluminum white pinstripe	Anthracite gray pinstripe

Table 14: 4PPC70.0573-22W, 4PPC70.0573-22B, 4PPC70.057L-22W, 4PPC70.057L-22B - Technical data

Product ID	4PPC70.0573-22W	4PPC70.0573-22B	4PPC70.057L-22W	4PPC70.057L-22B
Dimensions				
Width	172 mm			140 mm
Height	140 mm			172 mm
Depth			51 mm	

Table 14: 4PPC70.0573-22W, 4PPC70.0573-22B, 4PPC70.057L-22W, 4PPC70.057L-22B - Technical data

- 1) The real-time clock is buffered for approx. 1000 hours @ 25°C by a gold foil capacitor. The gold foil capacitor is completely charged after 18 continuous hours of operation.
- 2) Shortest cycle time that is suitable for average applications. In certain cases, it is also possible to use shorter cycle times. The limit for the setting is specified in the entry for the shortest task class cycle time.
- 3) See the POWERLINK help system under "General information, Hardware - IF/LS".
- 4) At an ambient temperature of 25°C. Reducing the brightness by 50% can typically result in an approximately 50% increase in the half-brightness time.
- 5) Remote stations connected via X2X Link, CAN bus, POWERLINK and Ethernet. Both USB interfaces are used.

2.4.1.2.4 Technical data 4PPC70.057x-23x

Product ID	4PPC70.0573-23W	4PPC70.0573-23B	4PPC70.057L-23W	4PPC70.057L-23B
General information				
Cooling	Fanless			
LEDs	Supply voltage OK, operating status, module status, Ethernet, POWERLINK, CAN Rx/Tx, RS485 Rx/Tx			
B&R ID code	0xE560	0xE4B5	0xE564	0xE568
System requirements	4.1.4.375 or higher			
Automation Studio	K4.08 or higher			
Automation Runtime	B4 or higher			
Support of X20SLX modules				
LEDs				
Quantity	9			
Power button	No			
Reset button	Yes			
Controller redundancy				
Master capability	No			
Buzzer	Yes			
ACOPOS capability	Yes			
Visual Components support	Yes			
Certification				
CE	Yes			
GOST-R	Yes			
Controller				
Boot loader	Automation Runtime AR 4.08			
CompactFlash slot	0			
DRAM	256 MB			
Real-time clock ¹⁾	Yes, resolution 1 s			
FPU	Yes			
Processor				
Type	Intel E620T			
Clock frequency	333 MHz			
L1 cache				
Data code	24 kB			
Program code	32 kB			
L2 cache	-			
Cooling	Passive			
Mode/Node switches	No			
Remanent variables	32 kB			
Typical shortest task class cycle time	1 ms ²⁾			
Shortest task class cycle time	0.4 ms			
Typical instruction cycle time	0.01 µs			
Application memory				
Type	2 GB eMMC flash memory			
Data retention	10 years			
Writable data amount				
Guaranteed	40 TB			
Results for 5 years	21.9 GB/day			
Guaranteed clear/write cycles	20,000			
Error correction coding (ECC)	Yes			
Interfaces				
IF1 interface				
Fieldbus	POWERLINK managing or controlled node			
Type	Type 4 ³⁾			
Design	1x RJ45 shielded			
Cable length	Max. 100 m between 2 nodes (segment length)			
Max. transfer rate	100 Mbit/s			
Transmission				
Physical interfaces	100BASE-TX			
Half-duplex	Yes			
Full-duplex	No			
Autonegotiation	Yes			
Auto-MDI / MDIX	Yes			
IF2 interface				
Type	Ethernet			
Design	1x RJ45 shielded			
Cable length	Max. 100 m between 2 nodes (segment length)			
Max. transfer rate	10/100 Mbit/s			
Transmission				
Physical interfaces	10BASE-T/100BASE-TX			
Half-duplex	Yes			
Full-duplex	Yes			
Autonegotiation	Yes			
Auto-MDI / MDIX	Yes			

Table 15: 4PPC70.0573-23W, 4PPC70.0573-23B, 4PPC70.057L-23W, 4PPC70.057L-23B - Technical data

Product ID	4PPC70.0573-23W	4PPC70.0573-23B	4PPC70.057L-23W	4PPC70.057L-23B
IF3 interface				
Type			USB 2.0	
Design			Type A	
Current load			0.49 A	
IF4 interface				
Type			USB 2.0	
Design			Type A	
Current load			0.10 A	
IF5 interface				
Type			X2X Link master	
IF6 interface				
Type			CAN bus	
Design			3 pins of the 6-pin multipoint connector	
Max. distance			1000 m	
Max. transfer rate				
Bus length ≤25 m			1 Mbit/s	
Bus length ≤60 m			500 kbit/s	
Bus length ≤200 m			250 kbit/s	
Bus length ≤1000 m			50 kbit/s	
IF9 interface				
Type			RS485	
Design			3 pins of the 6-pin multipoint connector	
Max. distance			1200 m	
Transfer rate			Max. 1152 kbit/s	
Display				
Type			Color TFT	
Display size			5.7"	
Colors			262,000	
Resolution		VGA, 640 x 480 pixels		VGA, 480 x 640 pixels
Contrast			Typ. 850:1	
Viewing angles				
Horizontal			Direction R / Direction L = typ. 80°	
Vertical			Direction U / Direction D = typ. 80°	
Backlight				
Type			LED	
Brightness			Typ. 400 cd/m ²	
Half-brightness time ⁴⁾			50,000 h	
Touch screen				
Type			AMT	
Technology			Analog resistive	
Controller			B&R, serial, 12-bit	
Transmittance			80% ±3%	
Screen rotation			Yes, using VC	
Electrical characteristics				
Nominal voltage			24 VDC -15% / +20%	
Max. power consumption ⁵⁾			14.4 W	
Reverse polarity protection			Yes	
Electrical isolation			No	
Operating conditions				
Installation at elevations above sea level				
0 to 2000 m			No limitations	
>2000 m			Reduction of ambient temperature by 0.5°C per 100 m	
EN 60529 protection			Back: IP20 Front: IP65	
Environmental conditions				
Temperature				
Operation				
Horizontal installation			0 to 50°C	
Vertical installation			0 to 50°C	
Storage			-20 to 60°C	
Transport			-20 to 60°C	
Relative humidity				
Operation			See humidity diagram	
Storage			See humidity diagram	
Transport			See humidity diagram	
Mechanical characteristics				
Note			Order 1x 0TB5104.2110-01, 1x 0TB5106.2110-01, 1x 0TB6102.2010-01 and 1x 0TB6102.2110-01 terminal block separately	
Front				
Design	Aluminum white pinstripe	Anthracite gray pinstripe	Aluminum white pinstripe	Anthracite gray pinstripe

Table 15: 4PPC70.0573-23W, 4PPC70.0573-23B, 4PPC70.057L-23W, 4PPC70.057L-23B - Technical data

Product ID	4PPC70.0573-23W	4PPC70.0573-23B	4PPC70.057L-23W	4PPC70.057L-23B
Dimensions				
Width	172 mm			140 mm
Height	140 mm			172 mm
Depth			51 mm	

Table 15: 4PPC70.0573-23W, 4PPC70.0573-23B, 4PPC70.057L-23W, 4PPC70.057L-23B - Technical data

- 1) The real-time clock is buffered for approx. 1000 hours @ 25°C by a gold foil capacitor. The gold foil capacitor is completely charged after 18 continuous hours of operation.
- 2) Shortest cycle time that is suitable for average applications. In certain cases, it is also possible to use shorter cycle times. The limit for the setting is specified in the entry for the shortest task class cycle time.
- 3) See the POWERLINK help system under "General information, Hardware - IF/LS".
- 4) At an ambient temperature of 25°C. Reducing the brightness by 50% can typically result in an approximately 50% increase in the half-brightness time.
- 5) Remote stations connected via X2X Link, CAN bus, POWERLINK and Ethernet. Both USB interfaces are used.

2.4.2 4PPC70.070x-2xx

2.4.2.1 4PPC70.070x-2xx - Order data

2.4.2.1.1 4PPC70.070x-20x - Order data

Model number	Short description	Figure
	C70	
4PPC70.0702-20W	Power Panel C70, 7", analog resistive touch screen, Intel ATOM 333 MHz comp., 256 MB DDRAM, 32 kB FRAM, 2 GB flash drive onboard, 1 X2X Link interface, 1 POWERLINK interface, 1 Ethernet interface 10BASE-T/100BASE-TX, 2 USB 2.0 interfaces, basic device without option board, landscape format, aluminum white pinstripe	
4PPC70.0702-20B	Power Panel C70, 7", analog resistive touch screen, Intel ATOM 333 MHz comp., 256 MB DDRAM, 32 kB FRAM, 2 GB flash drive onboard, 1 X2X Link interface, 1 POWERLINK interface, 1 Ethernet interface 10BASE-T/100BASE-TX, 2 USB 2.0 interfaces, basic device without option board, landscape format, anthracite gray pinstripe	
4PPC70.070M-20W	Power Panel C70, 7", analog resistive touch screen, Intel ATOM 333 MHz comp., 256 MB DDRAM, 32 kB FRAM, 2 GB flash drive onboard, 1 X2X Link interface, 1 POWERLINK interface, 1 Ethernet interface 10BASE-T/100BASE-TX, 2 USB 2.0 interfaces, basic device without option board, portrait format, aluminum white pinstripe	
4PPC70.070M-20B	Power Panel C70, 7", analog resistive touch screen, Intel ATOM 333 MHz comp., 256 MB DDRAM, 32 kB FRAM, 2 GB flash drive onboard, 1 X2X Link interface, 1 POWERLINK interface, 1 Ethernet interface 10BASE-T/100BASE-TX, 2 USB 2.0 interfaces, basic device without option board, portrait format, anthracite gray pinstripe	
	Required accessories	
	Terminal blocks	
0TB5104.2110-01	Accessory terminal block, 4-pin (2.5), cage clamp, 0.5 mm ²	
0TB6102.2010-01	Accessory terminal block, 2-pin (3.81), screw clamp 1.5 mm ²	
0TB6102.2110-01	Accessory terminal block, 2-pin (3.81), cage clamp, 1.5 mm ²	
	USB accessories	
5MMUSB.2048-01	USB 2.0 flash drive, 2048 MB, B&R	
5MMUSB.4096-01	USB 2.0 flash drive, 4096 MB, B&R	

Table 16: 4PPC70.0702-20W, 4PPC70.0702-20B, 4PPC70.070M-20W, 4PPC70.070M-20B - Order data

2.4.2.1.2 4PPC70.070x-21x - Order data

Model number	Short description	Figure
	C70	
4PPC70.0702-21W	Power Panel C70, 7", analog resistive touch screen, Intel ATOM 333 MHz comp., 256 MB DDRAM, 32 kB FRAM, 2 GB flash drive onboard, 1 X2X Link interface, 1 POWERLINK interface, 1 Ethernet interface 10BASE-T/100BASE-TX, 2 USB 2.0 interfaces, basic device with option board: 2x CAN bus, landscape format, aluminum white pinstripe	
4PPC70.0702-21B	Power Panel C70, 7", analog resistive touch screen, Intel ATOM 333 MHz comp., 256 MB DDRAM, 32 kB FRAM, 2 GB flash drive onboard, 1 X2X Link interface, 1 POWERLINK interface, 1 Ethernet interface 10BASE-T/100BASE-TX, 2 USB 2.0 interfaces, basic device with option board: 2x CAN bus, landscape format, anthracite gray pinstripe	
4PPC70.070M-21W	Power Panel C70, 7", analog resistive touch screen, Intel ATOM 333 MHz comp., 256 MB DDRAM, 32 kB FRAM, 2 GB flash drive onboard, 1 X2X Link interface, 1 POWERLINK interface, 1 Ethernet interface 10BASE-T/100BASE-TX, 2 USB 2.0 interfaces, basic device with option board: 2x CAN bus, portrait format, aluminum white pinstripe	
4PPC70.070M-21B	Power Panel C70, 7", analog resistive touch screen, Intel ATOM 333 MHz comp., 256 MB DDRAM, 32 kB FRAM, 2 GB flash drive onboard, 1 X2X Link interface, 1 POWERLINK interface, 1 Ethernet interface 10BASE-T/100BASE-TX, 2 USB 2.0 interfaces, basic device with option board: 2x CAN bus, portrait format, anthracite gray pinstripe	
	Required accessories	
	Terminal blocks	
0TB5104.2110-01	Accessory terminal block, 4-pin (2.5), cage clamp, 0.5 mm ²	
0TB5106.2110-01	Accessory terminal block, 6-pin (2.5), cage clamp, 0.5 mm ²	
0TB6102.2010-01	Accessory terminal block, 2-pin (3.81), screw clamp 1.5 mm ²	
0TB6102.2110-01	Accessory terminal block, 2-pin (3.81), cage clamp, 1.5 mm ²	
	USB accessories	
5MMUSB.2048-01	USB 2.0 flash drive, 2048 MB, B&R	
5MMUSB.4096-01	USB 2.0 flash drive, 4096 MB, B&R	

Table 17: 4PPC70.0702-21W, 4PPC70.0702-21B, 4PPC70.070M-21W, 4PPC70.070M-21B - Order data

2.4.2.1.3 4PPC70.070x-22x - Order data

Model number	Short description	Figure
	C70	
4PPC70.0702-22W	Power Panel C70, 7", analog resistive touch screen, Intel ATOM 333 MHz comp., 256 MB DDRAM, 32 kB FRAM, 2 GB flash drive onboard, 1 X2X Link interface, 1 POWERLINK interface, 1 Ethernet interface 10BASE-T/100BASE-TX, 2 USB 2.0 interfaces, basic device with option board: 1x CAN bus, 1x RS232, landscape format, aluminum white pinstripe	
4PPC70.0702-22B	Power Panel C70, 7", analog resistive touch screen, Intel ATOM 333 MHz comp., 256 MB DDRAM, 32 kB FRAM, 2 GB flash drive onboard, 1 X2X Link interface, 1 POWERLINK interface, 1 Ethernet interface 10BASE-T/100BASE-TX, 2 USB 2.0 interfaces, basic device with option board: 1x CAN bus, 1x RS232, landscape format, anthracite gray pinstripe	
4PPC70.070M-22W	Power Panel C70, 7", analog resistive touch screen, Intel ATOM 333 MHz comp., 256 MB DDRAM, 32 kB FRAM, 2 GB flash drive onboard, 1 X2X Link interface, 1 POWERLINK interface, 1 Ethernet interface 10BASE-T/100BASE-TX, 2 USB 2.0 interfaces, basic device with option board: 1x CAN bus, 1x RS232, portrait format, aluminum white pinstripe	
4PPC70.070M-22B	Power Panel C70, 7", analog resistive touch screen, Intel ATOM 333 MHz comp., 256 MB DDRAM, 32 kB FRAM, 2 GB flash drive onboard, 1 X2X Link interface, 1 POWERLINK interface, 1 Ethernet interface 10BASE-T/100BASE-TX, 2 USB 2.0 interfaces, basic device with option board: 1x CAN bus, 1x RS232, portrait format, anthracite gray pinstripe	
	Required accessories	
	Terminal blocks	
0TB5104.2110-01	Accessory terminal block, 4-pin (2.5), cage clamp, 0.5 mm ²	
0TB5106.2110-01	Accessory terminal block, 6-pin (2.5), cage clamp, 0.5 mm ²	
0TB6102.2010-01	Accessory terminal block, 2-pin (3.81), screw clamp 1.5 mm ²	
0TB6102.2110-01	Accessory terminal block, 2-pin (3.81), cage clamp, 1.5 mm ²	
	USB accessories	
5MMUSB.2048-01	USB 2.0 flash drive, 2048 MB, B&R	
5MMUSB.4096-01	USB 2.0 flash drive, 4096 MB, B&R	

Table 18: 4PPC70.0702-22W, 4PPC70.0702-22B, 4PPC70.070M-22W, 4PPC70.070M-22B - Order data

2.4.2.1.4 4PPC70.070x-23x - Order data

Model number	Short description	Figure
	C70	
4PPC70.0702-23W	Power Panel C70, 7", analog resistive touch screen, Intel ATOM 333 MHz comp., 256 MB DDRAM, 32 kB FRAM, 2 GB flash drive onboard, 1 X2X Link interface, 1 POWERLINK interface, 1 Ethernet interface 10BASE-T/100BASE-TX, 2 USB 2.0 interfaces, basic device with option board: 1x CAN bus, 1x RS485, landscape format, aluminum white pinstripe	
4PPC70.0702-23B	Power Panel C70, 7", analog resistive touch screen, Intel ATOM 333 MHz comp., 256 MB DDRAM, 32 kB FRAM, 2 GB flash drive onboard, 1 X2X Link interface, 1 POWERLINK interface, 1 Ethernet interface 10BASE-T/100BASE-TX, 2 USB 2.0 interfaces, basic device with option board: 1x CAN bus, 1x RS485, landscape format, anthracite gray pinstripe	
4PPC70.070M-23W	Power Panel C70, 7", analog resistive touch screen, Intel ATOM 333 MHz comp., 256 MB DDRAM, 32 kB FRAM, 2 GB flash drive onboard, 1 X2X Link interface, 1 POWERLINK interface, 1 Ethernet interface 10BASE-T/100BASE-TX, 2 USB 2.0 interfaces, basic device with option board: 1x CAN bus, 1x RS485, portrait format, aluminum white pinstripe	
4PPC70.070M-23B	Power Panel C70, 7", analog resistive touch screen, Intel ATOM 333 MHz comp., 256 MB DDRAM, 32 kB FRAM, 2 GB flash drive onboard, 1 X2X Link interface, 1 POWERLINK interface, 1 Ethernet interface 10BASE-T/100BASE-TX, 2 USB 2.0 interfaces, basic device with option board: 1x CAN bus, 1x RS485, portrait format, anthracite gray pinstripe	
	Required accessories	
	Terminal blocks	
0TB5104.2110-01	Accessory terminal block, 4-pin (2.5), cage clamp, 0.5 mm ²	
0TB5106.2110-01	Accessory terminal block, 6-pin (2.5), cage clamp, 0.5 mm ²	
0TB6102.2010-01	Accessory terminal block, 2-pin (3.81), screw clamp 1.5 mm ²	
0TB6102.2110-01	Accessory terminal block, 2-pin (3.81), cage clamp, 1.5 mm ²	
	USB accessories	
5MMUSB.2048-01	USB 2.0 flash drive, 2048 MB, B&R	
5MMUSB.4096-01	USB 2.0 flash drive, 4096 MB, B&R	

Table 19: 4PPC70.0702-23W, 4PPC70.0702-23B, 4PPC70.070M-23W, 4PPC70.070M-23B - Order data

2.4.2.2 Technical data 4PPC70.070x-2xx

2.4.2.2.1 Technical data 4PPC70.070x-20x

Product ID	4PPC70.0702-20W	4PPC70.0702-20B	4PPC70.070M-20W	4PPC70.070M-20B
General information				
Cooling	Fanless			
LEDs	Supply voltage OK, operating status, module status, Ethernet, POWERLINK			
B&R ID code	0xE569	0xE56D	0xE571	0xE575
System requirements				
Automation Studio	4.1.4.375 or higher			
Automation Runtime	K4.08 or higher			
Support of X20SLX modules	B4 or higher			
LEDs				
Quantity	4			
Power button	No			
Reset button	Yes			
Controller redundancy				
Master capability	No			
Buzzer	Yes			
ACOPOS capability	Yes			
Visual Components support	Yes			
Certification				
CE	Yes			
GOST-R	Yes			
Controller				
Boot loader	Automation Runtime AR 4.08			
CompactFlash slot	0			
DRAM	256 MB			
Real-time clock ¹⁾	Yes, resolution 1 s			
FPU	Yes			
Processor				
Type	Intel E620T			
Clock frequency	333 MHz			
L1 cache				
Data code	24 kB			
Program code	32 kB			
L2 cache	-			
Cooling	Passive			
Mode/Node switches	No			
Remanent variables	32 kB			
Typical shortest task class cycle time	1 ms ²⁾			
Shortest task class cycle time	0.4 ms			
Typical instruction cycle time	0.01 µs			
Application memory				
Type	2 GB eMMC flash memory			
Data retention	10 years			
Writable data amount				
Guaranteed	40 TB			
Results for 5 years	21.9 GB/day			
Guaranteed clear/write cycles	20,000			
Error correction coding (ECC)	Yes			
Interfaces				
IF1 interface				
Fieldbus	POWERLINK managing or controlled node			
Type	Type 4 ³⁾			
Design	1x RJ45 shielded			
Cable length	Max. 100 m between 2 nodes (segment length)			
Max. transfer rate	100 Mbit/s			
Transmission				
Physical interfaces	100BASE-TX			
Half-duplex	Yes			
Full-duplex	No			
Autonegotiation	Yes			
Auto-MDI / MDIX	Yes			

Table 20: 4PPC70.0702-20W, 4PPC70.0702-20B, 4PPC70.070M-20W, 4PPC70.070M-20B - Technical data

Product ID	4PPC70.0702-20W	4PPC70.0702-20B	4PPC70.070M-20W	4PPC70.070M-20B
IF2 interface				
Type	Ethernet			
Design	1x RJ45 shielded			
Cable length	Max. 100 m between 2 nodes (segment length)			
Max. transfer rate	10/100 Mbit/s			
Transmission				
Physical interfaces	10BASE-T/100BASE-TX			
Half-duplex	Yes			
Full-duplex	Yes			
Autonegotiation	Yes			
Auto-MDI / MDIX	Yes			
IF3 interface				
Type	USB 2.0			
Design	Type A			
Current load	0.49 A			
IF4 interface				
Type	USB 2.0			
Design	Type A			
Current load	0.10 A			
IF5 interface				
Type	X2X Link master			
Display				
Type	Color TFT			
Display size	7"			
Colors	262.000 / 16.2 M			
Resolution	WVGA, 800 x 480 pixels		WVGA, 480 x 800 pixels	
Contrast	Typ. 600:1			
Viewing angles				
Horizontal	Direction R / Direction L = typ. 60°		Direction R / Direction L = typ. 70°	
Vertical	Direction U / Direction D = typ. 70°		Direction U / Direction D = typ. 60°	
Backlight				
Type	LED			
Brightness	Typ. 500 cd/m ²			
Half-brightness time ⁴⁾	50,000 h			
Touch screen				
Type	AMT			
Technology	Analog resistive			
Controller	B&R, serial, 12-bit			
Transmittance	80% ±3%			
Screen rotation	Yes, using VC			
Electrical characteristics				
Nominal voltage	24 VDC -15% / +20%			
Max. power consumption ⁵⁾	15 W			
Reverse polarity protection	Yes			
Electrical isolation	No			
Operating conditions				
Installation at elevations above sea level				
0 to 2000 m	No limitations			
>2000 m	Reduction of ambient temperature by 0.5°C per 100 m			
EN 60529 protection	Back: IP20 Front: IP65			
Environmental conditions				
Temperature				
Operation				
Horizontal installation	0 to 50°C			
Vertical installation	0 to 50°C			
Storage	-20 to 60°C			
Transport	-20 to 60°C			
Relative humidity				
Operation	See humidity diagram			
Storage	See humidity diagram			
Transport	See humidity diagram			
Mechanical characteristics				
Note	Order 1x 0TB5104.2110-01, 1x 0TB6102.2010-01 and 1x 0TB6102.2110-01 terminal block separately			
Front				
Design	Aluminum white pinstripe	Anthracite gray pinstripe	Aluminum white pinstripe	Anthracite gray pinstripe
Dimensions				
Width	197 mm		140 mm	
Height	140 mm		197 mm	
Depth	51 mm			

Table 20: 4PPC70.0702-20W, 4PPC70.0702-20B, 4PPC70.070M-20W, 4PPC70.070M-20B - Technical data

- 1) The real-time clock is buffered for approx. 1000 hours @ 25°C by a gold foil capacitor. The gold foil capacitor is completely charged after 18 continuous hours of operation.
- 2) Shortest cycle time that is suitable for average applications. In certain cases, it is also possible to use shorter cycle times. The limit for the setting is specified in the entry for the shortest task class cycle time.

- 3) See the POWERLINK help system under "General information, Hardware - IF/LS".
- 4) At an ambient temperature of 25°C.
- 5) Remote stations connected via X2X Link, CAN bus, POWERLINK and Ethernet. Both USB interfaces are used.

2.4.2.2.2 Technical data 4PPC70.070x-21x

Product ID	4PPC70.0702-21W	4PPC70.0702-21B	4PPC70.070M-21W	4PPC70.070M-21B
General information				
Cooling	Fanless			
LEDs	Supply voltage OK, operating status, module status, Ethernet, POWERLINK, CAN Rx/Tx			
B&R ID code	0xE56A	0xE56E	0xE572	0xE576
System requirements	4.1.4.375 or higher			
Automation Studio	K4.08 or higher			
Automation Runtime	B4 or higher			
Support of X20SLX modules				
LEDs				
Quantity	9			
Power button	No			
Reset button	Yes			
Controller redundancy				
Master capability	No			
Buzzer	Yes			
ACOPOS capability	Yes			
Visual Components support	Yes			
Certification				
CE	Yes			
GOST-R	Yes			
Controller				
Boot loader	Automation Runtime AR 4.08			
CompactFlash slot	0			
DRAM	256 MB			
Real-time clock ¹⁾	Yes, resolution 1 s			
FPU	Yes			
Processor				
Type	Intel E620T			
Clock frequency	333 MHz			
L1 cache				
Data code	24 kB			
Program code	32 kB			
L2 cache	-			
Cooling	Passive			
Mode/Node switches	No			
Remanent variables	32 kB			
Typical shortest task class cycle time	1 ms ²⁾			
Shortest task class cycle time	0.4 ms			
Typical instruction cycle time	0.01 µs			
Application memory				
Type	2 GB eMMC flash memory			
Data retention	10 years			
Writable data amount				
Guaranteed	40 TB			
Results for 5 years	21.9 GB/day			
Guaranteed clear/write cycles	20,000			
Error correction coding (ECC)	Yes			
Interfaces				
IF1 interface				
Fieldbus	POWERLINK managing or controlled node			
Type	Type 4 ³⁾			
Design	1x RJ45 shielded			
Cable length	Max. 100 m between 2 nodes (segment length)			
Max. transfer rate	100 Mbit/s			
Transmission				
Physical interfaces	100BASE-T			
Half-duplex	Yes			
Full-duplex	No			
Autonegotiation	Yes			
Auto-MDI / MDIX	Yes			
IF2 interface				
Type	Ethernet			
Design	1x RJ45 shielded			
Cable length	Max. 100 m between 2 nodes (segment length)			
Max. transfer rate	10/100 Mbit/s			
Transmission				
Physical interfaces	10BASE-T/100BASE-TX			
Half-duplex	Yes			
Full-duplex	Yes			
Autonegotiation	Yes			
Auto-MDI / MDIX	Yes			

Table 21: 4PPC70.0702-21W, 4PPC70.0702-21B, 4PPC70.070M-21W, 4PPC70.070M-21B - Technical data

Product ID	4PPC70.0702-21W	4PPC70.0702-21B	4PPC70.070M-21W	4PPC70.070M-21B
IF3 interface				
Type	USB 2.0			
Design	Type A			
Current load	0.49 A			
IF4 interface				
Type	USB 2.0			
Design	Type A			
Current load	0.10 A			
IF5 interface				
Type	X2X Link master			
IF6 interface				
Type	CAN bus			
Design	3 pins of the 6-pin multipoint connector			
Max. distance	1000 m			
Max. transfer rate				
Bus length ≤25 m	1 Mbit/s			
Bus length ≤60 m	500 kbit/s			
Bus length ≤200 m	250 kbit/s			
Bus length ≤1000 m	50 kbit/s			
IF7 interface				
Type	CAN bus			
Design	3 pins of the 6-pin multipoint connector			
Max. distance	1000 m			
Max. transfer rate				
Bus length ≤25 m	1 Mbit/s			
Bus length ≤60 m	500 kbit/s			
Bus length ≤200 m	250 kbit/s			
Bus length ≤1000 m	50 kbit/s			
Display				
Type	Color TFT			
Display size	7"			
Colors	262.000 / 16.2 M			
Resolution	WVGA, 800 x 480 pixels		WVGA, 480 x 800 pixels	
Contrast	Typ. 600:1			
Viewing angles				
Horizontal	Direction R / Direction L = typ. 60°		Direction R / Direction L = typ. 70°	
Vertical	Direction U / Direction D = typ. 70°		Direction U / Direction D = typ. 60°	
Backlight				
Type	LED			
Brightness	Typ. 500 cd/m ²			
Half-brightness time ⁴⁾	50,000 h			
Touch screen				
Type	AMT			
Technology	Analog resistive			
Controller	B&R, serial, 12-bit			
Transmittance	80% ±3%			
Screen rotation	Yes, using VC			
Electrical characteristics				
Nominal voltage	24 VDC -15% / +20%			
Max. power consumption ⁵⁾	15 W			
Reverse polarity protection	Yes			
Electrical isolation	No			
Operating conditions				
Installation at elevations above sea level				
0 to 2000 m	No limitations			
>2000 m	Reduction of ambient temperature by 0.5°C per 100 m			
EN 60529 protection	Back: IP20 Front: IP65			
Environmental conditions				
Temperature				
Operation				
Horizontal installation	0 to 50°C			
Vertical installation	0 to 50°C			
Storage	-20 to 60°C			
Transport	-20 to 60°C			
Relative humidity				
Operation	See humidity diagram			
Storage	See humidity diagram			
Transport	See humidity diagram			
Mechanical characteristics				
Note	Order 1x 0TB5104.2110-01, 1x 0TB5106.2110-01, 1x 0TB6102.2010-01 and 1x 0TB6102.2110-01 terminal block separately			
Front				
Design	Aluminum white pinstripe	Anthracite gray pinstripe	Aluminum white pinstripe	Anthracite gray pinstripe

Table 21: 4PPC70.0702-21W, 4PPC70.0702-21B, 4PPC70.070M-21W, 4PPC70.070M-21B - Technical data

Product ID	4PPC70.0702-21W	4PPC70.0702-21B	4PPC70.070M-21W	4PPC70.070M-21B
Dimensions				
Width	197 mm			140 mm
Height	140 mm			197 mm
Depth			51 mm	

Table 21: 4PPC70.0702-21W, 4PPC70.0702-21B, 4PPC70.070M-21W, 4PPC70.070M-21B - Technical data

- 1) The real-time clock is buffered for approx. 1000 hours @ 25°C by a gold foil capacitor. The gold foil capacitor is completely charged after 18 continuous hours of operation.
- 2) Shortest cycle time that is suitable for average applications. In certain cases, it is also possible to use shorter cycle times. The limit for the setting is specified in the entry for the shortest task class cycle time.
- 3) See the POWERLINK help system under "General information, Hardware - IF/LS".
- 4) At an ambient temperature of 25°C.
- 5) Remote stations connected via X2X Link, CAN bus, POWERLINK and Ethernet. Both USB interfaces are used.

2.4.2.2.3 Technical data 4PPC70.070x-22x

Product ID	4PPC70.0702-22W	4PPC70.0702-22B	4PPC70.070M-22W	4PPC70.070M-22B
General information				
Cooling	Fanless			
LEDs	Supply voltage OK, operating status, module status, Ethernet, POWERLINK, CAN Rx/Tx, RS232 Rx/Tx			
B&R ID code	0xE56B	0xE56F	0xE573	0xE577
System requirements				
Automation Studio	4.1.4.375 or higher			
Automation Runtime	K4.08 or higher			
Support of X20SLX modules	B4 or higher			
LEDs				
Quantity	9			
Power button	No			
Reset button	Yes			
Controller redundancy				
Master capability	No			
Buzzer	Yes			
ACOPOS capability	Yes			
Visual Components support	Yes			
Certification				
CE	Yes			
GOST-R	Yes			
Controller				
Boot loader	Automation Runtime AR 4.08			
CompactFlash slot	0			
DRAM	256 MB			
Real-time clock ¹⁾	Yes, resolution 1 s			
FPU	Yes			
Processor				
Type	Intel E620T			
Clock frequency	333 MHz			
L1 cache				
Data code	24 kB			
Program code	32 kB			
L2 cache	-			
Cooling	Passive			
Mode/Node switches	No			
Remanent variables	32 kB			
Typical shortest task class cycle time	1 ms ²⁾			
Shortest task class cycle time	0.4 ms			
Typical instruction cycle time	0.01 µs			
Application memory				
Type	2 GB eMMC flash memory			
Data retention	10 years			
Writable data amount				
Guaranteed	40 TB			
Results for 5 years	21.9 GB/day			
Guaranteed clear/write cycles	20,000			
Error correction coding (ECC)	Yes			
Interfaces				
IF1 interface				
Fieldbus	POWERLINK managing or controlled node			
Type	Type 4 ³⁾			
Design	1x RJ45 shielded			
Cable length	Max. 100 m between 2 nodes (segment length)			
Max. transfer rate	100 Mbit/s			
Transmission				
Physical interfaces	100BASE-TX			
Half-duplex	Yes			
Full-duplex	No			
Autonegotiation	Yes			
Auto-MDI / MDIX	Yes			
IF2 interface				
Type	Ethernet			
Design	1x RJ45 shielded			
Cable length	Max. 100 m between 2 nodes (segment length)			
Max. transfer rate	10/100 Mbit/s			
Transmission				
Physical interfaces	10BASE-T/100BASE-TX			
Half-duplex	Yes			
Full-duplex	Yes			
Autonegotiation	Yes			
Auto-MDI / MDIX	Yes			

Table 22: 4PPC70.0702-22W, 4PPC70.0702-22B, 4PPC70.070M-22W, 4PPC70.070M-22B - Technical data

Power Panel C-Series • C-Series

Product ID	4PPC70.0702-22W	4PPC70.0702-22B	4PPC70.070M-22W	4PPC70.070M-22B
IF3 interface				
Type	USB 2.0			
Design	Type A			
Current load	0.49 A			
IF4 interface				
Type	USB 2.0			
Design	Type A			
Current load	0.10 A			
IF5 interface				
Type	X2X Link master			
IF6 interface				
Type	CAN bus			
Design	3 pins of the 6-pin multipoint connector			
Max. distance	1000 m			
Max. transfer rate				
Bus length ≤25 m	1 Mbit/s			
Bus length ≤60 m	500 kbit/s			
Bus length ≤200 m	250 kbit/s			
Bus length ≤1000 m	50 kbit/s			
IF8 interface				
Type	RS232			
Design	3 pins of the 6-pin multipoint connector			
Max. distance	900 m			
Transfer rate	Max. 1152 kbit/s			
Display				
Type	Color TFT			
Display size	7"			
Colors	262.000 / 16.2 M			
Resolution	WVGA, 800 x 480 pixels		WVGA, 480 x 800 pixels	
Contrast	Typ. 600:1			
Viewing angles				
Horizontal	Direction R / Direction L = typ. 60°		Direction R / Direction L = typ. 70°	
Vertical	Direction U / Direction D = typ. 70°		Direction U / Direction D = typ. 60°	
Backlight				
Type	LED			
Brightness	Typ. 500 cd/m ²			
Half-brightness time ⁴⁾	50,000 h			
Touch screen				
Type	AMT			
Technology	Analog resistive			
Controller	B&R, serial, 12-bit			
Transmittance	80% ±3%			
Screen rotation	Yes, using VC			
Electrical characteristics				
Nominal voltage	24 VDC -15% / +20%			
Max. power consumption ⁵⁾	15 W			
Reverse polarity protection	Yes			
Electrical isolation	No			
Operating conditions				
Installation at elevations above sea level				
0 to 2000 m	No limitations			
>2000 m	Reduction of ambient temperature by 0.5°C per 100 m			
EN 60529 protection	Back: IP20 Front: IP65			
Environmental conditions				
Temperature				
Operation				
Horizontal installation	0 to 50°C			
Vertical installation	0 to 50°C			
Storage	-20 to 60°C			
Transport	-20 to 60°C			
Relative humidity				
Operation	See humidity diagram			
Storage	See humidity diagram			
Transport	See humidity diagram			
Mechanical characteristics				
Note	Order 1x 0TB5104.2110-01, 1x 0TB5106.2110-01, 1x 0TB6102.2010-01 and 1x 0TB6102.2110-01 terminal block separately			
Front				
Design	Aluminum white pinstripe	Anthracite gray pinstripe	Aluminum white pinstripe	Anthracite gray pinstripe

Table 22: 4PPC70.0702-22W, 4PPC70.0702-22B, 4PPC70.070M-22W, 4PPC70.070M-22B - Technical data

Product ID	4PPC70.0702-22W	4PPC70.0702-22B	4PPC70.070M-22W	4PPC70.070M-22B
Dimensions				
Width	197 mm			140 mm
Height	140 mm			197 mm
Depth			51 mm	

Table 22: 4PPC70.0702-22W, 4PPC70.0702-22B, 4PPC70.070M-22W, 4PPC70.070M-22B - Technical data

- 1) The real-time clock is buffered for approx. 1000 hours @ 25°C by a gold foil capacitor. The gold foil capacitor is completely charged after 18 continuous hours of operation.
- 2) Shortest cycle time that is suitable for average applications. In certain cases, it is also possible to use shorter cycle times. The limit for the setting is specified in the entry for the shortest task class cycle time.
- 3) See the POWERLINK help system under "General information, Hardware - IF/LS".
- 4) At an ambient temperature of 25°C.
- 5) Remote stations connected via X2X Link, CAN bus, POWERLINK and Ethernet. Both USB interfaces are used.

2.4.2.2.4 Technical data 4PPC70.070x-23x

Product ID	4PPC70.0702-23W	4PPC70.0702-23B	4PPC70.070M-23W	4PPC70.070M-23B
General information				
Cooling	Fanless			
LEDs	Supply voltage OK, operating status, module status, Ethernet, POWERLINK, CAN Rx/Tx, RS485 Rx/Tx			
B&R ID code	0xE56C	0xE570	0xE574	0xE578
System requirements	4.1.4.375 or higher			
Automation Studio	K4.08 or higher			
Automation Runtime	B4 or higher			
Support of X20SLX modules				
LEDs				
Quantity	9			
Power button	No			
Reset button	Yes			
Controller redundancy				
Master capability	No			
Buzzer	Yes			
ACOPOS capability	Yes			
Visual Components support	Yes			
Certification				
CE	Yes			
GOST-R	Yes			
Controller				
Boot loader	Automation Runtime AR 4.08			
CompactFlash slot	0			
DRAM	256 MB			
Real-time clock ¹⁾	Yes, resolution 1 s			
FPU	Yes			
Processor				
Type	Intel E620T			
Clock frequency	333 MHz			
L1 cache				
Data code	24 kB			
Program code	32 kB			
L2 cache	-			
Cooling	Passive			
Mode/Node switches	No			
Remanent variables	32 kB			
Typical shortest task class cycle time	1 ms ²⁾			
Shortest task class cycle time	0.4 ms			
Typical instruction cycle time	0.01 µs			
Application memory				
Type	2 GB eMMC flash memory			
Data retention	10 years			
Writable data amount				
Guaranteed	40 TB			
Results for 5 years	21.9 GB/day			
Guaranteed clear/write cycles	20,000			
Error correction coding (ECC)	Yes			
Interfaces				
IF1 interface				
Fieldbus	POWERLINK managing or controlled node			
Type	Type 4 ³⁾			
Design	1x RJ45 shielded			
Cable length	Max. 100 m between 2 nodes (segment length)			
Max. transfer rate	100 Mbit/s			
Transmission				
Physical interfaces	100BASE-TX			
Half-duplex	Yes			
Full-duplex	No			
Autonegotiation	Yes			
Auto-MDI / MDIX	Yes			
IF2 interface				
Type	Ethernet			
Design	1x RJ45 shielded			
Cable length	Max. 100 m between 2 nodes (segment length)			
Max. transfer rate	10/100 Mbit/s			
Transmission				
Physical interfaces	10BASE-T/100BASE-TX			
Half-duplex	Yes			
Full-duplex	Yes			
Autonegotiation	Yes			
Auto-MDI / MDIX	Yes			

Table 23: 4PPC70.0702-23W, 4PPC70.0702-23B, 4PPC70.070M-23W, 4PPC70.070M-23B - Technical data

Product ID	4PPC70.0702-23W	4PPC70.0702-23B	4PPC70.070M-23W	4PPC70.070M-23B
IF3 interface				
Type	USB 2.0			
Design	Type A			
Current load	0.49 A			
IF4 interface				
Type	USB 2.0			
Design	Type A			
Current load	0.10 A			
IF5 interface				
Type	X2X Link master			
IF6 interface				
Type	CAN bus			
Design	3 pins of the 6-pin multipoint connector			
Max. distance	1000 m			
Max. transfer rate				
Bus length ≤25 m	1 Mbit/s			
Bus length ≤60 m	500 kbit/s			
Bus length ≤200 m	250 kbit/s			
Bus length ≤1000 m	50 kbit/s			
IF9 interface				
Type	RS485			
Design	3 pins of the 6-pin multipoint connector			
Max. distance	1200 m			
Transfer rate	Max. 1152 kbit/s			
Display				
Type	Color TFT			
Display size	7"			
Colors	262,000 / 16.2 M			
Resolution	WVGA, 800 x 480 pixels		WVGA, 480 x 800 pixels	
Contrast	Typ. 600:1			
Viewing angles				
Horizontal	Direction R / Direction L = typ. 60°		Direction R / Direction L = typ. 70°	
Vertical	Direction U / Direction D = typ. 70°		Direction U / Direction D = typ. 60°	
Backlight				
Type	LED			
Brightness	Typ. 500 cd/m ²			
Half-brightness time ⁴⁾	50,000 h			
Touch screen				
Type	AMT			
Technology	Analog resistive			
Controller	B&R, serial, 12-bit			
Transmittance	80% ±3%			
Screen rotation	Yes, using VC			
Electrical characteristics				
Nominal voltage	24 VDC -15% / +20%			
Max. power consumption ⁵⁾	15 W			
Reverse polarity protection	Yes			
Electrical isolation	No			
Operating conditions				
Installation at elevations above sea level				
0 to 2000 m	No limitations			
>2000 m	Reduction of ambient temperature by 0.5°C per 100 m			
EN 60529 protection	Back: IP20 Front: IP65			
Environmental conditions				
Temperature				
Operation				
Horizontal installation	0 to 50°C			
Vertical installation	0 to 50°C			
Storage	-20 to 60°C			
Transport	-20 to 60°C			
Relative humidity				
Operation	See humidity diagram			
Storage	See humidity diagram			
Transport	See humidity diagram			
Mechanical characteristics				
Note	Order 1x 0TB5104.2110-01, 1x 0TB5106.2110-01, 1x 0TB6102.2010-01 and 1x 0TB6102.2110-01 terminal block separately			
Front				
Design	Aluminum white pinstripe	Anthracite gray pinstripe	Aluminum white pinstripe	Anthracite gray pinstripe

Table 23: 4PPC70.0702-23W, 4PPC70.0702-23B, 4PPC70.070M-23W, 4PPC70.070M-23B - Technical data

Product ID	4PPC70.0702-23W	4PPC70.0702-23B	4PPC70.070M-23W	4PPC70.070M-23B
Dimensions				
Width	197 mm			140 mm
Height	140 mm			197 mm
Depth			51 mm	

Table 23: 4PPC70.0702-23W, 4PPC70.0702-23B, 4PPC70.070M-23W, 4PPC70.070M-23B - Technical data

- 1) The real-time clock is buffered for approx. 1000 hours @ 25°C by a gold foil capacitor. The gold foil capacitor is completely charged after 18 continuous hours of operation.
- 2) Shortest cycle time that is suitable for average applications. In certain cases, it is also possible to use shorter cycle times. The limit for the setting is specified in the entry for the shortest task class cycle time.
- 3) See the POWERLINK help system under "General information, Hardware - IF/LS".
- 4) At an ambient temperature of 25°C.
- 5) Remote stations connected via X2X Link, CAN bus, POWERLINK and Ethernet. Both USB interfaces are used.

2.4.3 4PPC70.101x-2xx

2.4.3.1 4PPC70.101x-2xx - Order data

2.4.3.1.1 4PPC70.101x-20x - Order data

Model number	Short description	Figure
	C70	
4PPC70.101G-20W	Power Panel C70, 10.1", analog resistive touch screen, Intel ATOM 333 MHz comp., 256 MB DDRAM, 32 kB FRAM, 2 GB flash drive onboard, 1 X2X Link interface, 1 POWERLINK interface, 1 Ethernet interface 10BASE-T/100BASE-TX, 2 USB 2.0 interfaces, basic device without option board, landscape format, aluminum white pinstripe	
4PPC70.101G-20B	Power Panel C70, 10.1", analog resistive touch screen, Intel ATOM 333 MHz comp., 256 MB DDRAM, 32 kB FRAM, 2 GB flash drive onboard, 1 X2X Link interface, 1 POWERLINK interface, 1 Ethernet interface 10BASE-T/100BASE-TX, 2 USB 2.0 interfaces, basic device without option board, landscape format, anthracite gray pinstripe	
4PPC70.101N-20W	Power Panel C70, 10.1", analog resistive touch screen, Intel ATOM 333 MHz comp., 256 MB DDRAM, 32 kB FRAM, 2 GB flash drive onboard, 1 X2X Link interface, 1 POWERLINK interface, 1 Ethernet interface 10BASE-T/100BASE-TX, 2 USB 2.0 interfaces, basic device without option board, portrait format, aluminum white pinstripe	
4PPC70.101N-20B	Power Panel C70, 10.1", analog resistive touch screen, Intel ATOM 333 MHz comp., 256 MB DDRAM, 32 kB FRAM, 2 GB flash drive onboard, 1 X2X Link interface, 1 POWERLINK interface, 1 Ethernet interface 10BASE-T/100BASE-TX, 2 USB 2.0 interfaces, basic device without option board, portrait format, anthracite gray pinstripe	
	Required accessories	
	Terminal blocks	
0TB5104.2110-01	Accessory terminal block, 4-pin (2.5), cage clamp, 0.5 mm ²	
0TB6102.2010-01	Accessory terminal block, 2-pin (3.81), screw clamp 1.5 mm ²	
0TB6102.2110-01	Accessory terminal block, 2-pin (3.81), cage clamp, 1.5 mm ²	
	USB accessories	
5MMUSB.2048-01	USB 2.0 flash drive, 2048 MB, B&R	
5MMUSB.4096-01	USB 2.0 flash drive, 4096 MB, B&R	

Table 24: 4PPC70.101G-20W, 4PPC70.101G-20B, 4PPC70.101N-20W, 4PPC70.101N-20B - Order data

2.4.3.1.2 4PPC70.101x-21x - Order data

Model number	Short description	Figure
	C70	
4PPC70.101G-21W	Power Panel C70, 10.1", analog resistive touch screen, Intel ATOM 333 MHz comp., 256 MB DDRAM, 32 kB FRAM, 2 GB flash drive onboard, 1 X2X Link interface, 1 POWERLINK interface, 1 Ethernet interface 10BASE-T/100BASE-TX, 2 USB 2.0 interfaces, basic device with option board: 2x CAN bus, landscape format, aluminum white pinstripe	
4PPC70.101G-21B	Power Panel C70, 10.1", analog resistive touch screen, Intel ATOM 333 MHz comp., 256 MB DDRAM, 32 kB FRAM, 2 GB flash drive onboard, 1 X2X Link interface, 1 POWERLINK interface, 1 Ethernet interface 10BASE-T/100BASE-TX, 2 USB 2.0 interfaces, basic device with option board: 2x CAN bus, landscape format, anthracite gray pinstripe	
4PPC70.101N-21W	Power Panel C70, 10.1", analog resistive touch screen, Intel ATOM 333 MHz comp., 256 MB DDRAM, 32 kB FRAM, 2 GB flash drive onboard, 1 X2X Link interface, 1 POWERLINK interface, 1 Ethernet interface 10BASE-T/100BASE-TX, 2 USB 2.0 interfaces, basic device with option board: 2x CAN bus, portrait format, aluminum white pinstripe	
4PPC70.101N-21B	Power Panel C70, 10.1", analog resistive touch screen, Intel ATOM 333 MHz comp., 256 MB DDRAM, 32 kB FRAM, 2 GB flash drive onboard, 1 X2X Link interface, 1 POWERLINK interface, 1 Ethernet interface 10BASE-T/100BASE-TX, 2 USB 2.0 interfaces, basic device with option board: 2x CAN bus, portrait format, anthracite gray pinstripe	
	Required accessories	
	Terminal blocks	
0TB5104.2110-01	Accessory terminal block, 4-pin (2.5), cage clamp, 0.5 mm ²	
0TB5106.2110-01	Accessory terminal block, 6-pin (2.5), cage clamp, 0.5 mm ²	
0TB6102.2010-01	Accessory terminal block, 2-pin (3.81), screw clamp 1.5 mm ²	
0TB6102.2110-01	Accessory terminal block, 2-pin (3.81), cage clamp, 1.5 mm ²	
	USB accessories	
5MMUSB.2048-01	USB 2.0 flash drive, 2048 MB, B&R	
5MMUSB.4096-01	USB 2.0 flash drive, 4096 MB, B&R	

Table 25: 4PPC70.101G-21W, 4PPC70.101G-21B, 4PPC70.101N-21W, 4PPC70.101N-21B - Order data

2.4.3.1.3 4PPC70.101x-22x - Order data

Model number	Short description	Figure
	C70	
4PPC70.101G-22W	Power Panel C70, 10.1", analog resistive touch screen, Intel ATOM 333 MHz comp., 256 MB DDRAM, 32 kB FRAM, 2 GB flash drive onboard, 1 X2X Link interface, 1 POWERLINK interface, 1 Ethernet interface 10BASE-T/100BASE-TX, 2 USB 2.0 interfaces, basic device with option board: 1x CAN bus, 1x RS232, landscape format, aluminum white pinstripe	
4PPC70.101G-22B	Power Panel C70, 10.1", analog resistive touch screen, Intel ATOM 333 MHz comp., 256 MB DDRAM, 32 kB FRAM, 2 GB flash drive onboard, 1 X2X Link interface, 1 POWERLINK interface, 1 Ethernet interface 10BASE-T/100BASE-TX, 2 USB 2.0 interfaces, basic device with option board: 1x CAN bus, 1x RS232, landscape format, anthracite gray pinstripe	
4PPC70.101N-22W	Power Panel C70, 10.1", analog resistive touch screen, Intel ATOM 333 MHz comp., 256 MB DDRAM, 32 kB FRAM, 2 GB flash drive onboard, 1 X2X Link interface, 1 POWERLINK interface, 1 Ethernet interface 10BASE-T/100BASE-TX, 2 USB 2.0 interfaces, basic device with option board: 1x CAN bus, 1x RS232, portrait format, aluminum white pinstripe	
4PPC70.101N-22B	Power Panel C70, 10.1", analog resistive touch screen, Intel ATOM 333 MHz comp., 256 MB DDRAM, 32 kB FRAM, 2 GB flash drive onboard, 1 X2X Link interface, 1 POWERLINK interface, 1 Ethernet interface 10BASE-T/100BASE-TX, 2 USB 2.0 interfaces, basic device with option board: 1x CAN bus, 1x RS232, portrait format, anthracite gray pinstripe	
	Required accessories	
	Terminal blocks	
0TB5104.2110-01	Accessory terminal block, 4-pin (2.5), cage clamp, 0.5 mm ²	
0TB5106.2110-01	Accessory terminal block, 6-pin (2.5), cage clamp, 0.5 mm ²	
0TB6102.2010-01	Accessory terminal block, 2-pin (3.81), screw clamp 1.5 mm ²	
0TB6102.2110-01	Accessory terminal block, 2-pin (3.81), cage clamp, 1.5 mm ²	
	USB accessories	
5MMUSB.2048-01	USB 2.0 flash drive, 2048 MB, B&R	
5MMUSB.4096-01	USB 2.0 flash drive, 4096 MB, B&R	

Table 26: 4PPC70.101G-22W, 4PPC70.101G-22B, 4PPC70.101N-22W, 4PPC70.101N-22B - Order data

2.4.3.1.4 4PPC70.101x-23x - Order data

Model number	Short description	Figure
	C70	
4PPC70.101G-23W	Power Panel C70, 10.1", analog resistive touch screen, Intel ATOM 333 MHz comp., 256 MB DDRAM, 32 kB FRAM, 2 GB flash drive onboard, 1 X2X Link interface, 1 POWERLINK interface, 1 Ethernet interface 10BASE-T/100BASE-TX, 2 USB 2.0 interfaces, basic device with option board: 1x CAN bus, 1x RS485, landscape format, aluminum white pinstripe	
4PPC70.101G-23B	Power Panel C70, 10.1", analog resistive touch screen, Intel ATOM 333 MHz comp., 256 MB DDRAM, 32 kB FRAM, 2 GB flash drive onboard, 1 X2X Link interface, 1 POWERLINK interface, 1 Ethernet interface 10BASE-T/100BASE-TX, 2 USB 2.0 interfaces, basic device with option board: 1x CAN bus, 1x RS485, landscape format, anthracite gray pinstripe	
4PPC70.101N-23W	Power Panel C70, 10.1", analog resistive touch screen, Intel ATOM 333 MHz comp., 256 MB DDRAM, 32 kB FRAM, 2 GB flash drive onboard, 1 X2X Link interface, 1 POWERLINK interface, 1 Ethernet interface 10BASE-T/100BASE-TX, 2 USB 2.0 interfaces, basic device with option board: 1x CAN bus, 1x RS485, portrait format, aluminum white pinstripe	
4PPC70.101N-23B	Power Panel C70, 10.1", analog resistive touch screen, Intel ATOM 333 MHz comp., 256 MB DDRAM, 32 kB FRAM, 2 GB flash drive onboard, 1 X2X Link interface, 1 POWERLINK interface, 1 Ethernet interface 10BASE-T/100BASE-TX, 2 USB 2.0 interfaces, basic device with option board: 1x CAN bus, 1x RS485, portrait format, anthracite gray pinstripe	
	Required accessories	
	Terminal blocks	
0TB5104.2110-01	Accessory terminal block, 4-pin (2.5), cage clamp, 0.5 mm ²	
0TB5106.2110-01	Accessory terminal block, 6-pin (2.5), cage clamp, 0.5 mm ²	
0TB6102.2010-01	Accessory terminal block, 2-pin (3.81), screw clamp 1.5 mm ²	
0TB6102.2110-01	Accessory terminal block, 2-pin (3.81), cage clamp, 1.5 mm ²	
	USB accessories	
5MMUSB.2048-01	USB 2.0 flash drive, 2048 MB, B&R	
5MMUSB.4096-01	USB 2.0 flash drive, 4096 MB, B&R	

Table 27: 4PPC70.101G-23W, 4PPC70.101G-23B, 4PPC70.101N-23W, 4PPC70.101N-23B - Order data

2.4.3.2 Technical data 4PPC70.101x-2xx

2.4.3.2.1 Technical data 4PPC70.101x-20x

Product ID	4PPC70.101G-20W	4PPC70.101G-20B	4PPC70.101N-20W	4PPC70.101N-20B
General information				
Cooling	Fanless			
LEDs	Supply voltage OK, operating status, module status, Ethernet, POWERLINK			
B&R ID code	0xE579	0xE57D	0xE581	0xE585
System requirements				
Automation Studio	4.1.4.375 or higher			
Automation Runtime	K4.08 or higher			
Support of X20SLX modules	B4 or higher			
LEDs				
Quantity	4			
Power button	No			
Reset button	Yes			
Controller redundancy				
Master capability	No			
Buzzer	Yes			
ACOPOS capability	Yes			
Visual Components support	Yes			
Certification				
CE	Yes			
GOST-R	Yes			
Controller				
Boot loader	Automation Runtime AR 4.08			
CompactFlash slot	0			
DRAM	256 MB			
Real-time clock ¹⁾	Yes, resolution 1 s			
FPU	Yes			
Processor				
Type	Intel E620T			
Clock frequency	333 MHz			
L1 cache				
Data code	24 kB			
Program code	32 kB			
L2 cache	-			
Cooling	Passive			
Mode/Node switches	No			
Remanent variables	32 kB			
Typical shortest task class cycle time	1 ms ²⁾			
Shortest task class cycle time	0.4 ms			
Typical instruction cycle time	0.01 µs			
Application memory				
Type	2 GB eMMC flash memory			
Data retention	10 years			
Writable data amount				
Guaranteed	40 TB			
Results for 5 years	21.9 GB/day			
Guaranteed clear/write cycles	20,000			
Error correction coding (ECC)	Yes			
Interfaces				
IF1 interface				
Fieldbus	POWERLINK managing or controlled node			
Type	Type 4 ³⁾			
Design	1x RJ45 shielded			
Cable length	Max. 100 m between 2 nodes (segment length)			
Max. transfer rate	100 Mbit/s			
Transmission				
Physical interfaces	100BASE-TX			
Half-duplex	Yes			
Full-duplex	No			
Autonegotiation	Yes			
Auto-MDI / MDIX	Yes			

Table 28: 4PPC70.101G-20W, 4PPC70.101G-20B, 4PPC70.101N-20W, 4PPC70.101N-20B - Technical data

Product ID	4PPC70.101G-20W	4PPC70.101G-20B	4PPC70.101N-20W	4PPC70.101N-20B
IF2 interface				
Type	Ethernet			
Design	1x RJ45 shielded			
Cable length	Max. 100 m between 2 nodes (segment length)			
Max. transfer rate	10/100 Mbit/s			
Transmission				
Physical interfaces	10BASE-T/100BASE-TX			
Half-duplex	Yes			
Full-duplex	Yes			
Autonegotiation	Yes			
Auto-MDI / MDIX	Yes			
IF3 interface				
Type	USB 2.0			
Design	Type A			
Current load	0.49 A			
IF4 interface				
Type	USB 2.0			
Design	Type A			
Current load	0.10 A			
IF5 interface				
Type	X2X Link master			
Display				
Type	Color TFT			
Display size	10.1"			
Colors	16.2 M			
Resolution	WSVGA, 1024 x 600 pixels		WSVGA, 600 x 1024 pixels	
Contrast ⁴⁾	Typ. 500:1			
Viewing angles				
Horizontal	Direction R / Direction L = typ. 70°			
Vertical	Direction U / Direction D = typ. 70°			
Backlight				
Type	LED			
Brightness ⁴⁾	Typ. 500 cd/m ²			
Half-brightness time ⁴⁾	50,000 h			
Touch screen				
Type	AMT			
Technology	Analog resistive			
Controller	B&R, serial, 12-bit			
Transmittance	80% ±3%			
Screen rotation	Yes, using VC			
Electrical characteristics				
Nominal voltage	24 VDC -15% / +20%			
Max. power consumption ⁵⁾	14.5 W			
Reverse polarity protection	Yes			
Electrical isolation	No			
Operating conditions				
Installation at elevations above sea level				
0 to 2000 m	No limitations			
>2000 m	Reduction of ambient temperature by 0.5°C per 100 m			
EN 60529 protection	Back: IP20 Front: IP65			
Environmental conditions				
Temperature				
Operation				
Horizontal installation	0 to 50°C			
Vertical installation	0 to 50°C			
Storage	-20 to 60°C			
Transport	-20 to 60°C			
Relative humidity				
Operation	See humidity diagram			
Storage	See humidity diagram			
Transport	See humidity diagram			
Mechanical characteristics				
Note	Order 1x 0TB5104.2110-01, 1x 0TB6102.2010-01 and 1x 0TB6102.2110-01 terminal block separately			
Front				
Design	Aluminum white pinstripe	Anthracite gray pinstripe	Aluminum white pinstripe	Anthracite gray pinstripe
Dimensions				
Width	276 mm		172 mm	
Height	172 mm		276 mm	
Depth	51 mm			

Table 28: 4PPC70.101G-20W, 4PPC70.101G-20B, 4PPC70.101N-20W, 4PPC70.101N-20B - Technical data

- 1) The real-time clock is buffered for approx. 1000 hours @ 25°C by a gold foil capacitor. The gold foil capacitor is completely charged after 18 continuous hours of operation.
- 2) Shortest cycle time that is suitable for average applications. In certain cases, it is also possible to use shorter cycle times. The limit for the setting is specified in the entry for the shortest task class cycle time.

- 3) See the POWERLINK help system under "General information, Hardware - IF/LS".
- 4) At an ambient temperature of 25°C.
- 5) Remote stations connected via X2X Link, CAN bus, POWERLINK and Ethernet. Both USB interfaces are used.

2.4.3.2.2 Technical data 4PPC70.101x-21x

Product ID	4PPC70.101G-21W	4PPC70.101G-21B	4PPC70.101N-21W	4PPC70.101N-21B
General information				
Cooling	Fanless			
LEDs	Supply voltage OK, operating status, module status, Ethernet, POWERLINK, CAN Rx/Tx			
B&R ID code	0xE57A	0xE57E	0xE582	0xE586
System requirements				
Automation Studio	4.1.4.375 or higher			
Automation Runtime	K4.08 or higher			
Support of X20SLX modules	B4 or higher			
LEDs				
Quantity	9			
Power button	No			
Reset button	Yes			
Controller redundancy				
Master capability	No			
Buzzer	Yes			
ACOPOS capability	Yes			
Visual Components support	Yes			
Certification				
CE	Yes			
GOST-R	Yes			
Controller				
Boot loader	Automation Runtime AR 4.08			
CompactFlash slot	0			
DRAM	256 MB			
Real-time clock ¹⁾	Yes, resolution 1 s			
FPU	Yes			
Processor				
Type	Intel E620T			
Clock frequency	333 MHz			
L1 cache				
Data code	24 kB			
Program code	32 kB			
L2 cache	-			
Cooling	Passive			
Mode/Node switches	No			
Remanent variables	32 kB			
Typical shortest task class cycle time	1 ms ²⁾			
Shortest task class cycle time	0.4 ms			
Typical instruction cycle time	0.01 µs			
Application memory				
Type	2 GB eMMC flash memory			
Data retention	10 years			
Writable data amount				
Guaranteed	40 TB			
Results for 5 years	21.9 GB/day			
Guaranteed clear/write cycles	20,000			
Error correction coding (ECC)	Yes			
Interfaces				
IF1 interface				
Fieldbus	POWERLINK managing or controlled node			
Type	Type 4 ³⁾			
Design	1x RJ45 shielded			
Cable length	Max. 100 m between 2 nodes (segment length)			
Max. transfer rate	100 Mbit/s			
Transmission				
Physical interfaces	100BASE-TX			
Half-duplex	Yes			
Full-duplex	No			
Autonegotiation	Yes			
Auto-MDI / MDIX	Yes			
IF2 interface				
Type	Ethernet			
Design	1x RJ45 shielded			
Cable length	Max. 100 m between 2 nodes (segment length)			
Max. transfer rate	10/100 Mbit/s			
Transmission				
Physical interfaces	10BASE-T/100BASE-TX			
Half-duplex	Yes			
Full-duplex	Yes			
Autonegotiation	Yes			
Auto-MDI / MDIX	Yes			

Table 29: 4PPC70.101G-21W, 4PPC70.101G-21B, 4PPC70.101N-21W, 4PPC70.101N-21B - Technical data

Product ID	4PPC70.101G-21W	4PPC70.101G-21B	4PPC70.101N-21W	4PPC70.101N-21B
IF3 interface				
Type	USB 2.0			
Design	Type A			
Current load	0.49 A			
IF4 interface				
Type	USB 2.0			
Design	Type A			
Current load	0.10 A			
IF5 interface				
Type	X2X Link master			
IF6 interface				
Type	CAN bus			
Design	3 pins of the 6-pin multipoint connector			
Max. distance	1000 m			
Max. transfer rate				
Bus length ≤25 m	1 Mbit/s			
Bus length ≤60 m	500 kbit/s			
Bus length ≤200 m	250 kbit/s			
Bus length ≤1000 m	50 kbit/s			
IF7 interface				
Type	CAN bus			
Design	3 pins of the 6-pin multipoint connector			
Max. distance	1000 m			
Max. transfer rate				
Bus length ≤25 m	1 Mbit/s			
Bus length ≤60 m	500 kbit/s			
Bus length ≤200 m	250 kbit/s			
Bus length ≤1000 m	50 kbit/s			
Display				
Type	Color TFT			
Display size	10.1"			
Colors	16.2 M			
Resolution	WSVGA, 1024 x 600 pixels		WSVGA, 600 x 1024 pixels	
Contrast ⁴⁾	Typ. 500:1			
Viewing angles				
Horizontal	Direction R / Direction L = typ. 70°			
Vertical	Direction U / Direction D = typ. 70°			
Backlight				
Type	LED			
Brightness ⁴⁾	Typ. 500 cd/m ²			
Half-brightness time ⁴⁾	50,000 h			
Touch screen				
Type	AMT			
Technology	Analog resistive			
Controller	B&R, serial, 12-bit			
Transmittance	80% ±3%			
Screen rotation	Yes, using VC			
Electrical characteristics				
Nominal voltage	24 VDC -15% / +20%			
Max. power consumption ⁵⁾	14.5 W			
Reverse polarity protection	Yes			
Electrical isolation	No			
Operating conditions				
Installation at elevations above sea level				
0 to 2000 m	No limitations			
>2000 m	Reduction of ambient temperature by 0.5°C per 100 m			
EN 60529 protection	Back: IP20 Front: IP65			
Environmental conditions				
Temperature				
Operation				
Horizontal installation	0 to 50°C			
Vertical installation	0 to 50°C			
Storage	-20 to 60°C			
Transport	-20 to 60°C			
Relative humidity				
Operation	See humidity diagram			
Storage	See humidity diagram			
Transport	See humidity diagram			
Mechanical characteristics				
Note	Order 1x 0TB5104.2110-01, 1x 0TB5106.2110-01, 1x 0TB6102.2010-01 and 1x 0TB6102.2110-01 terminal block separately			
Front				
Design	Aluminum white pinstripe	Anthracite gray pinstripe	Aluminum white pinstripe	Anthracite gray pinstripe

Table 29: 4PPC70.101G-21W, 4PPC70.101G-21B, 4PPC70.101N-21W, 4PPC70.101N-21B - Technical data

Product ID	4PPC70.101G-21W	4PPC70.101G-21B	4PPC70.101N-21W	4PPC70.101N-21B
Dimensions				
Width	276 mm			172 mm
Height	172 mm			276 mm
Depth			51 mm	

Table 29: 4PPC70.101G-21W, 4PPC70.101G-21B, 4PPC70.101N-21W, 4PPC70.101N-21B - Technical data

- 1) The real-time clock is buffered for approx. 1000 hours @ 25°C by a gold foil capacitor. The gold foil capacitor is completely charged after 18 continuous hours of operation.
- 2) Shortest cycle time that is suitable for average applications. In certain cases, it is also possible to use shorter cycle times. The limit for the setting is specified in the entry for the shortest task class cycle time.
- 3) See the POWERLINK help system under "General information, Hardware - IF/LS".
- 4) At an ambient temperature of 25°C.
- 5) Remote stations connected via X2X Link, CAN bus, POWERLINK and Ethernet. Both USB interfaces are used.

2.4.3.2.3 Technical data 4PPC70.101x-22x

Product ID	4PPC70.101G-22W	4PPC70.101G-22B	4PPC70.101N-22W	4PPC70.101N-22B
General information				
Cooling	Fanless			
LEDs	Supply voltage OK, operating status, module status, Ethernet, POWERLINK, CAN Rx/Tx, RS232 Rx/Tx			
B&R ID code	0xE57B	0xE57F	0xE583	0xE587
System requirements				
Automation Studio	4.1.4.375 or higher			
Automation Runtime	K4.08 or higher			
Support of X20SLX modules	B4 or higher			
LEDs				
Quantity	9			
Power button	No			
Reset button	Yes			
Controller redundancy				
Master capability	No			
Buzzer	Yes			
ACOPOS capability	Yes			
Visual Components support	Yes			
Certification				
CE	Yes			
GOST-R	Yes			
Controller				
Boot loader	Automation Runtime AR 4.08			
CompactFlash slot	0			
DRAM	256 MB			
Real-time clock ¹⁾	Yes, resolution 1 s			
FPU	Yes			
Processor				
Type	Intel E620T			
Clock frequency	333 MHz			
L1 cache				
Data code	24 kB			
Program code	32 kB			
L2 cache	-			
Cooling	Passive			
Mode/Node switches	No			
Remanent variables	32 kB			
Typical shortest task class cycle time	1 ms ²⁾			
Shortest task class cycle time	0.4 ms			
Typical instruction cycle time	0.01 µs			
Application memory				
Type	2 GB eMMC flash memory			
Data retention	10 years			
Writable data amount				
Guaranteed	40 TB			
Results for 5 years	21.9 GB/day			
Guaranteed clear/write cycles	20,000			
Error correction coding (ECC)	Yes			
Interfaces				
IF1 interface				
Fieldbus	POWERLINK managing or controlled node			
Type	Type 4 ³⁾			
Design	1x RJ45 shielded			
Cable length	Max. 100 m between 2 nodes (segment length)			
Max. transfer rate	100 Mbit/s			
Transmission				
Physical interfaces	100BASE-TX			
Half-duplex	Yes			
Full-duplex	No			
Autonegotiation	Yes			
Auto-MDI / MDIX	Yes			
IF2 interface				
Type	Ethernet			
Design	1x RJ45 shielded			
Cable length	Max. 100 m between 2 nodes (segment length)			
Max. transfer rate	10/100 Mbit/s			
Transmission				
Physical interfaces	10BASE-T/100BASE-TX			
Half-duplex	Yes			
Full-duplex	Yes			
Autonegotiation	Yes			
Auto-MDI / MDIX	Yes			

Table 30: 4PPC70.101G-22W, 4PPC70.101G-22B, 4PPC70.101N-22W, 4PPC70.101N-22B - Technical data

Power Panel C-Series • C-Series

Product ID	4PPC70.101G-22W	4PPC70.101G-22B	4PPC70.101N-22W	4PPC70.101N-22B
IF3 interface				
Type	USB 2.0			
Design	Type A			
Current load	0.49 A			
IF4 interface				
Type	USB 2.0			
Design	Type A			
Current load	0.10 A			
IF5 interface				
Type	X2X Link master			
IF6 interface				
Type	CAN bus			
Design	3 pins of the 6-pin multipoint connector			
Max. distance	1000 m			
Max. transfer rate				
Bus length ≤25 m	1 Mbit/s			
Bus length ≤60 m	500 kbit/s			
Bus length ≤200 m	250 kbit/s			
Bus length ≤1000 m	50 kbit/s			
IF8 interface				
Type	RS232			
Design	3 pins of the 6-pin multipoint connector			
Max. distance	900 m			
Transfer rate	Max. 1152 kbit/s			
Display				
Type	Color TFT			
Display size	10.1"			
Colors	16.2 M			
Resolution	WSVGA, 1024 x 600 pixels		WSVGA, 600 x 1024 pixels	
Contrast ⁴⁾	Typ. 500:1			
Viewing angles				
Horizontal	Direction R / Direction L = typ. 70°			
Vertical	Direction U / Direction D = typ. 70°			
Backlight				
Type	LED			
Brightness ⁴⁾	Typ. 500 cd/m ²			
Half-brightness time ⁴⁾	50,000 h			
Touch screen				
Type	AMT			
Technology	Analog resistive			
Controller	B&R, serial, 12-bit			
Transmittance	80% ±3%			
Screen rotation	Yes, using VC			
Electrical characteristics				
Nominal voltage	24 VDC -15% / +20%			
Max. power consumption ⁵⁾	14.5 W			
Reverse polarity protection	Yes			
Electrical isolation	No			
Operating conditions				
Installation at elevations above sea level				
0 to 2000 m	No limitations			
>2000 m	Reduction of ambient temperature by 0.5°C per 100 m			
EN 60529 protection	Back: IP20 Front: IP65			
Environmental conditions				
Temperature				
Operation				
Horizontal installation	0 to 50°C			
Vertical installation	0 to 50°C			
Storage	-20 to 60°C			
Transport	-20 to 60°C			
Relative humidity				
Operation	See humidity diagram			
Storage	See humidity diagram			
Transport	See humidity diagram			
Mechanical characteristics				
Note	Order 1x 0TB5104.2110-01, 1x 0TB5106.2110-01, 1x 0TB6102.2010-01 and 1x 0TB6102.2110-01 terminal block separately			
Front				
Design	Aluminum white pinstripe	Anthracite gray pinstripe	Aluminum white pinstripe	Anthracite gray pinstripe

Table 30: 4PPC70.101G-22W, 4PPC70.101G-22B, 4PPC70.101N-22W, 4PPC70.101N-22B - Technical data

Product ID	4PPC70.101G-22W	4PPC70.101G-22B	4PPC70.101N-22W	4PPC70.101N-22B
Dimensions				
Width	276 mm			172 mm
Height	172 mm			276 mm
Depth			51 mm	

Table 30: 4PPC70.101G-22W, 4PPC70.101G-22B, 4PPC70.101N-22W, 4PPC70.101N-22B - Technical data

- 1) The real-time clock is buffered for approx. 1000 hours @ 25°C by a gold foil capacitor. The gold foil capacitor is completely charged after 18 continuous hours of operation.
- 2) Shortest cycle time that is suitable for average applications. In certain cases, it is also possible to use shorter cycle times. The limit for the setting is specified in the entry for the shortest task class cycle time.
- 3) See the POWERLINK help system under "General information, Hardware - IF/LS".
- 4) At an ambient temperature of 25°C.
- 5) Remote stations connected via X2X Link, CAN bus, POWERLINK and Ethernet. Both USB interfaces are used.

2.4.3.2.4 Technical data 4PPC70.101x-23x

Product ID	4PPC70.101G-23W	4PPC70.101G-23B	4PPC70.101N-23W	4PPC70.101N-23B
General information				
Cooling	Fanless			
LEDs	Supply voltage OK, operating status, module status, Ethernet, POWERLINK, CAN Rx/Tx, RS485 Rx/Tx			
B&R ID code	0xE57C	0xE580	0xE584	0xE588
System requirements	4.1.4.375 or higher			
Automation Studio	K4.08 or higher			
Automation Runtime	B4 or higher			
Support of X20SLX modules				
LEDs				
Quantity	9			
Power button	No			
Reset button	Yes			
Controller redundancy				
Master capability	No			
Buzzer	Yes			
ACOPOS capability	Yes			
Visual Components support	Yes			
Certification				
CE	Yes			
GOST-R	Yes			
Controller				
Boot loader	Automation Runtime AR 4.08			
CompactFlash slot	0			
DRAM	256 MB			
Real-time clock ¹⁾	Yes, resolution 1 s			
FPU	Yes			
Processor				
Type	Intel E620T			
Clock frequency	333 MHz			
L1 cache				
Data code	24 kB			
Program code	32 kB			
L2 cache	-			
Cooling	Passive			
Mode/Node switches	No			
Remanent variables	32 kB			
Typical shortest task class cycle time	1 ms ²⁾			
Shortest task class cycle time	0.4 ms			
Typical instruction cycle time	0.01 µs			
Application memory				
Type	2 GB eMMC flash memory			
Data retention	10 years			
Writable data amount				
Guaranteed	40 TB			
Results for 5 years	21.9 GB/day			
Guaranteed clear/write cycles	20,000			
Error correction coding (ECC)	Yes			
Interfaces				
IF1 interface				
Fieldbus	POWERLINK managing or controlled node			
Type	Type 4 ³⁾			
Design	1x RJ45 shielded			
Cable length	Max. 100 m between 2 nodes (segment length)			
Max. transfer rate	100 Mbit/s			
Transmission				
Physical interfaces	100BASE-TX			
Half-duplex	Yes			
Full-duplex	No			
Autonegotiation	Yes			
Auto-MDI / MDIX	Yes			
IF2 interface				
Type	Ethernet			
Design	1x RJ45 shielded			
Cable length	Max. 100 m between 2 nodes (segment length)			
Max. transfer rate	10/100 Mbit/s			
Transmission				
Physical interfaces	10BASE-T/100BASE-TX			
Half-duplex	Yes			
Full-duplex	Yes			
Autonegotiation	Yes			
Auto-MDI / MDIX	Yes			

Table 31: 4PPC70.101G-23W, 4PPC70.101G-23B, 4PPC70.101N-23W, 4PPC70.101N-23B - Technical data

Product ID	4PPC70.101G-23W	4PPC70.101G-23B	4PPC70.101N-23W	4PPC70.101N-23B
IF3 interface				
Type			USB 2.0	
Design			Type A	
Current load			0.49 A	
IF4 interface				
Type			USB 2.0	
Design			Type A	
Current load			0.10 A	
IF5 interface				
Type			X2X Link master	
IF6 interface				
Type			CAN bus	
Design			3 pins of the 6-pin multipoint connector	
Max. distance			1000 m	
Max. transfer rate				
Bus length ≤25 m			1 Mbit/s	
Bus length ≤60 m			500 kbit/s	
Bus length ≤200 m			250 kbit/s	
Bus length ≤1000 m			50 kbit/s	
IF9 interface				
Type			RS485	
Design			3 pins of the 6-pin multipoint connector	
Max. distance			1200 m	
Transfer rate			Max. 1152 kbit/s	
Display				
Type			Color TFT	
Display size			10.1"	
Colors			16.2 M	
Resolution		WSVGA, 1024 x 600 pixels		WSVGA, 600 x 1024 pixels
Contrast ⁴⁾			Typ. 500:1	
Viewing angles				
Horizontal			Direction R / Direction L = typ. 70°	
Vertical			Direction U / Direction D = typ. 70°	
Backlight				
Type			LED	
Brightness ⁴⁾			Typ. 500 cd/m ²	
Half-brightness time ⁴⁾			50,000 h	
Touch screen				
Type			AMT	
Technology			Analog resistive	
Controller			B&R, serial, 12-bit	
Transmittance			80% ±3%	
Screen rotation			Yes, using VC	
Electrical characteristics				
Nominal voltage			24 VDC -15% / +20%	
Max. power consumption ⁵⁾			14.5 W	
Reverse polarity protection			Yes	
Electrical isolation			No	
Operating conditions				
Installation at elevations above sea level				
0 to 2000 m			No limitations	
>2000 m			Reduction of ambient temperature by 0.5°C per 100 m	
EN 60529 protection			Back: IP20 Front: IP65	
Environmental conditions				
Temperature				
Operation				
Horizontal installation			0 to 50°C	
Vertical installation			0 to 50°C	
Storage			-20 to 60°C	
Transport			-20 to 60°C	
Relative humidity				
Operation			See humidity diagram	
Storage			See humidity diagram	
Transport			See humidity diagram	
Mechanical characteristics				
Note			Order 1x 0TB5104.2110-01, 1x 0TB5106.2110-01, 1x 0TB6102.2010-01 and 1x 0TB6102.2110-01 terminal block separately	
Front				
Design	Aluminum white pinstripe	Anthracite gray pinstripe	Aluminum white pinstripe	Anthracite gray pinstripe

Table 31: 4PPC70.101G-23W, 4PPC70.101G-23B, 4PPC70.101N-23W, 4PPC70.101N-23B - Technical data

Product ID	4PPC70.101G-23W	4PPC70.101G-23B	4PPC70.101N-23W	4PPC70.101N-23B
Dimensions				
Width	276 mm			172 mm
Height	172 mm			276 mm
Depth			51 mm	

Table 31: 4PPC70.101G-23W, 4PPC70.101G-23B, 4PPC70.101N-23W, 4PPC70.101N-23B - Technical data

- 1) The real-time clock is buffered for approx. 1000 hours @ 25°C by a gold foil capacitor. The gold foil capacitor is completely charged after 18 continuous hours of operation.
- 2) Shortest cycle time that is suitable for average applications. In certain cases, it is also possible to use shorter cycle times. The limit for the setting is specified in the entry for the shortest task class cycle time.
- 3) See the POWERLINK help system under "General information, Hardware - IF/LS".
- 4) At an ambient temperature of 25°C.
- 5) Remote stations connected via X2X Link, CAN bus, POWERLINK and Ethernet. Both USB interfaces are used.

2.4.4 Diagnostic LEDs

Nine diagnostic LEDs are found on the back of Power Panel C-Series devices:



Figure 5: Diagnostic LEDs

2.4.4.1 Diagnostic LEDs - 4PPC70.xxxx-2xx

LED	Color	Status	Description
R/E	Green	On	Application running
	Red	On	SERVICE or BOOT mode
		Double flash	BOOT mode (during firmware update)
RDY/F	Yellow	On	SERVICE or BOOT mode
S/E	Green/Red		Status/Error LED. The statuses of this LED are described in section 2.4.4.2 "'S/E" LED" on page 61.
PLK	Green	On	Link established to the remote station
		Blinking	A link to the remote station has been established and there is Ethernet activity on the bus.
OPS1 ¹	-	-	NC
OPS2 ¹	Green	On	CAN RxD
OPS3 ¹	Yellow	On	CAN TxD
OPS4 ¹	Green	On	RxD of the respective interface
OPS5 ¹	Yellow	On	TxD of the respective interface

Table 32: Diagnostic LEDs - 4PPC70.xxxx-2xx

¹ Planned feature (implementation to follow)

2.4.4.2 "S/E" LED

The Status/Error LED is a green/red dual LED. The LED status can have different meanings depending on the operating mode.

Ethernet mode

In this mode, the interface is operated as an Ethernet interface.

Green - Status	Description
On	Operates the interface as an Ethernet interface

Table 33: Diagnostic LEDs - 4PPC70.xxx-20x - "S/E" LED - Ethernet mode

POWERLINK

Red - Error	Description
On	<p>The module is in an error mode (failed Ethernet frames, increased number of collisions on the network, etc.). If an error occurs in the following states, then the green LED blinks over the red LED:</p> <ul style="list-style-type: none"> • PRE_OPERATIONAL_1 • PRE_OPERATIONAL_2 • READY_TO_OPERATE  <p>Note: The LED blinks red several times immediately after startup. This is not an error.</p>

Table 34: Diagnostic LEDs 4PPC70.xxx-20x - "S/E" LED - POWERLINK - Error

Green - Status	Description
Off NOT_ACTIVE	<p>Mode The module is in NOT_ACTIVE mode or:</p> <ul style="list-style-type: none"> • Switched off • Starting up • Not configured correctly in Automation Studio • Defective <p>Managing node (MN) The bus is monitored for POWERLINK frames. If a frame is not received within the configured time window (timeout), the module goes directly into PRE_OPERATIONAL_1 mode (single flash). If POWERLINK communication is detected before the time expires, however, then the MN will not be started.</p> <p>Controlled node (CN) The bus is monitored for POWERLINK frames. If a corresponding frame is not received within the defined time frame (timeout), then the module will directly enter BASIC_ETHERNET mode (flickering). If POWERLINK communication is detected before this time passes, however, the module goes directly into PRE_OPERATIONAL_1 mode (single flash).</p>
Green flickering (approx. 10 Hz) BASIC_ETHERNET	<p>Mode The module is in BASIC_ETHERNET mode. The interface is operated as an Ethernet TCP/IP interface.</p> <p>Managing node (MN) This state can only be changed by resetting the module.</p> <p>Controlled node (CN) If POWERLINK communication is detected while in this state, the module goes into the PRE_OPERATIONAL_1 state (single flash).</p>
Single flash (approx. 1 Hz) PRE_OPERATIONAL_1	<p>Mode The module is in PRE_OPERATIONAL_1 mode.</p> <p>Managing node (MN) The MN starts "reduced cycle" operation. Cyclic communication is not yet taking place.</p> <p>Controlled node (CN) The module can be configured by the MN in this state. The CN waits until it receives an SoC frame and then goes into the PRE_OPERATIONAL_2 state (double flash). An LED lit red in this state indicates a failure of the MN.</p>
Double flash (approx. 1 Hz) PRE_OPERATIONAL_2	<p>Mode The module is in PRE_OPERATIONAL_2 mode.</p> <p>Managing node (MN) The MN begins cyclic communication (cyclic input data is not yet evaluated). The CNs are configured in this state.</p> <p>Controlled node (CN) The module can be configured by the MN in this state. After this, a command changes the state to READY_TO_OPERATE (triple flash). An LED lit red in this mode indicates a failure of the MN.</p>

Table 35: Diagnostic LEDs - 4PPC70.xxx-20x - "S/E" LED - Status

Green - Status	Description
Triple flash (approx. 1 Hz) READY_TO_OPERATE	<p>Mode The module is in the READY_TO_OPERATE state.</p> <p>Managing node (MN) Cyclic and asynchronous communication. The received PDO data is ignored.</p> <p>Controlled node (CN) The module configuration is complete. Normal cyclic and asynchronous communication. The PDO data sent corresponds to the PDO mapping. Cyclic data is not yet evaluated, however. An LED lit red in this mode indicates a failure of the MN.</p>
On OPERATIONAL	<p>Mode The module is in PRE_OPERATIONAL_2 mode. PDO mapping is active and cyclic data is being evaluated.</p>
Blinking (approx. 2.5 Hz) STOPPED	<p>Mode The module is in STOPPED mode.</p> <p>Managing node (MN) This status is not possible for the MN.</p> <p>Controlled node (CN) No output data is produced, and no input data is supplied. It is only possible to enter or leave this mode after the MN has given the appropriate command.</p>

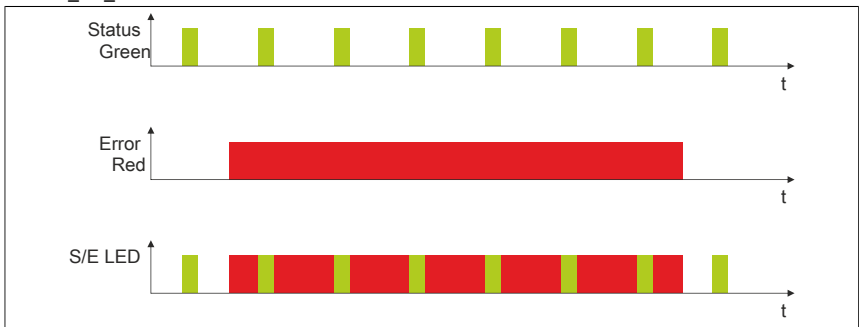
Table 35: Diagnostic LEDs - 4PPC70.xxx-20x - "S/E" LED - Status

2.4.4.3 System failure error codes

Incorrect configuration or defective hardware can cause a system failure error code.

The error code is indicated by the red error LED using four switch-on phases. The switch-on phases have a duration of either 150 ms or 600 ms. The error code is output cyclically every 2 seconds.

Error description	Error code indicated by red status LED									
RAM error: The module is defective and must be replaced.	•	•	•	-	Pause	•	•	•	-	Pause
Hardware error: The module or a system component is defective and must be replaced.	-	•	•	-	Pause	-	•	•	-	Pause

Table 36: Diagnostic LEDs 4PPC70.xxxx-20x - System failure error codes

Key	•	... 150 ms
	-	... 600 ms
	Pause	2 second delay

2.4.4.4 Ethernet and POWERLINK LEDs

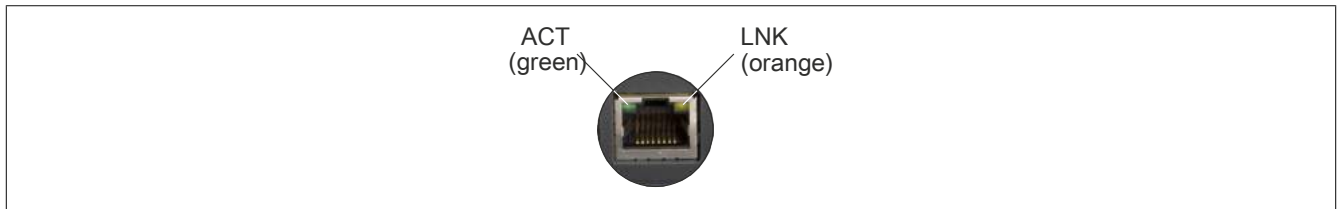

Figure 6: Ethernet and POWERLINK LEDs

LED	Color	Status	Description
ACT	Green	On	Application running
	Red	On	SERVICE mode
LNK	Orange	On	No Ethernet or POWERLINK activity on the bus
		Blinking	Ethernet or POWERLINK activity on the bus

Table 37: Ethernet and POWERLINK LEDs

2.4.5 Reset button

The reset button can be used to switch between operating modes, depending on how it is pressed.

- Reset hardware (RUN): Short press (<2 seconds)
- Diagnostic mode (DIAG): Long press (>2 seconds)
- Start mode (BOOT): Short press (<2 seconds), followed by a long press (>2 seconds)

A warm or cold restart triggered from Automation Studio always results in RUN mode.

2.4.6 Temperature/Humidity diagram

4PPC70.057x-2xx

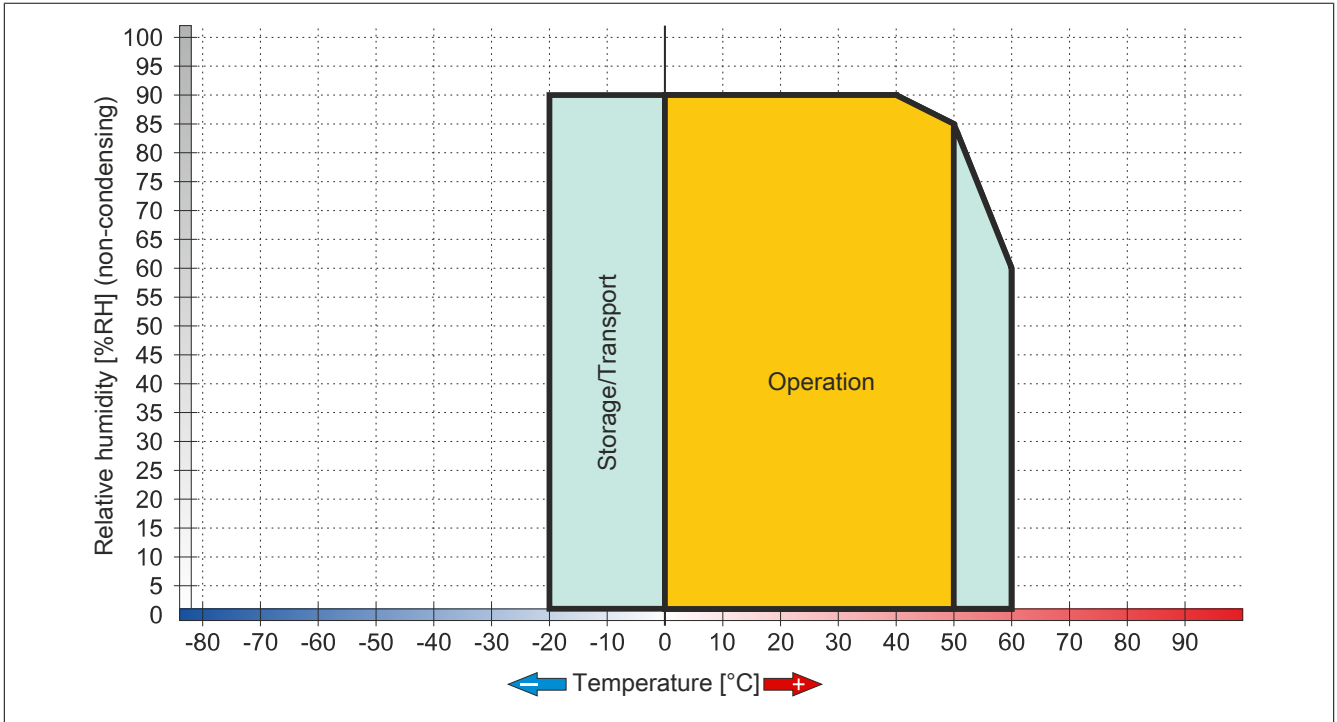

4PPC70.070x-2xx

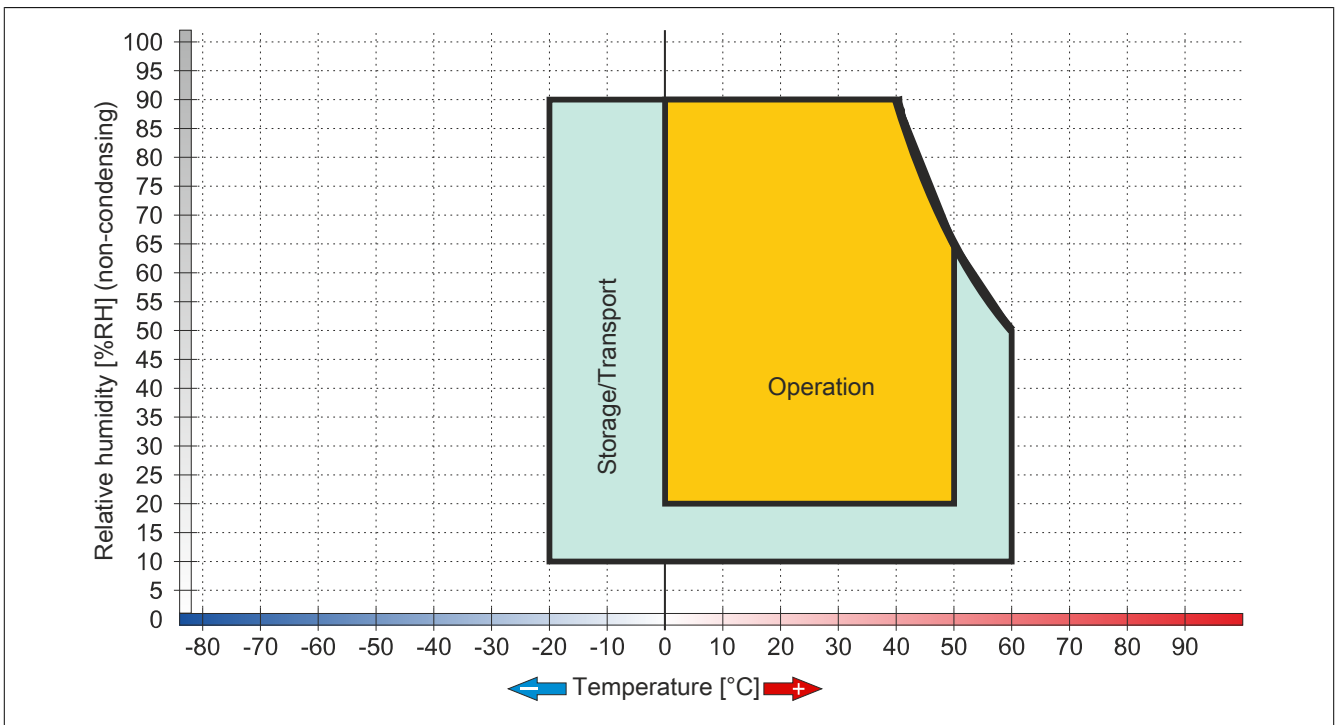

4PPC70.101x-2xx

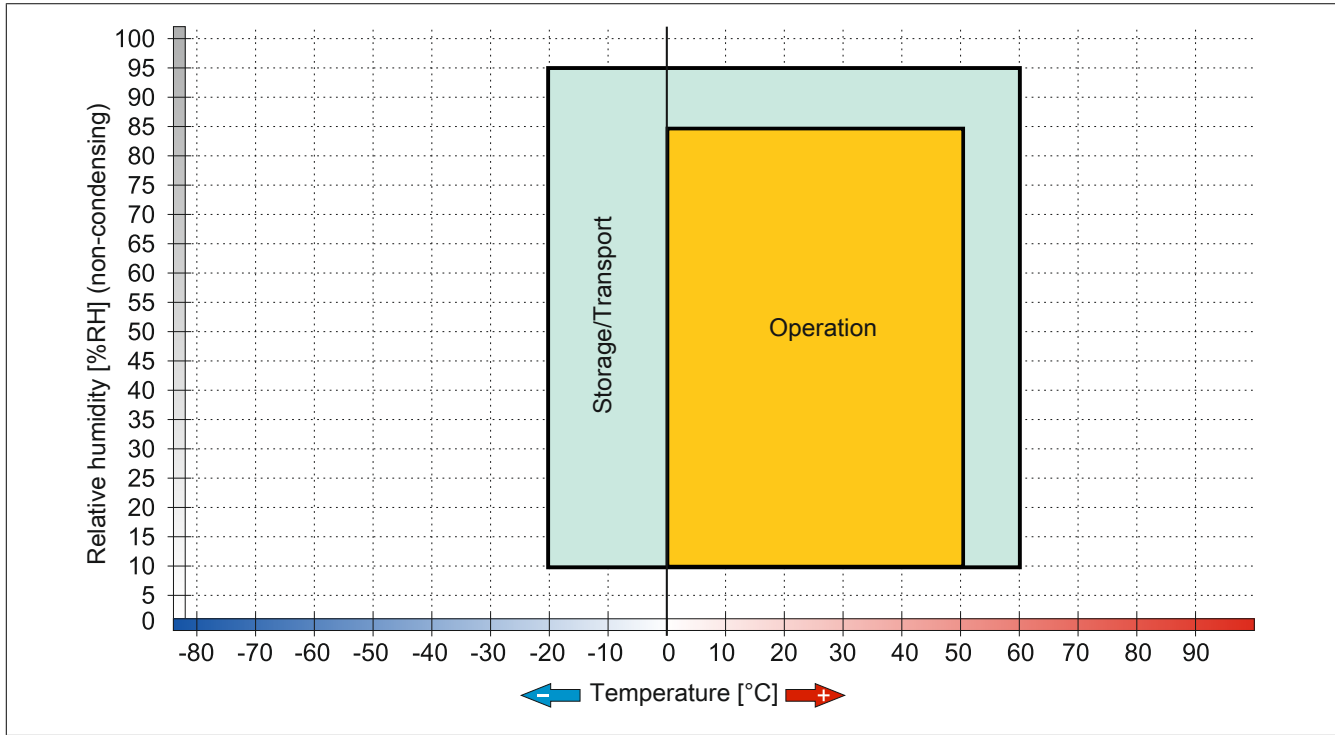

Figure 9: 4PPC70.101x-2xx - Temperature/Humidity diagram

2.4.7 Connection elements

2.4.7.1 POWERLINK interface

Interface	Pinout		
POWERLINK interface  Shielded RJ45	Terminal	POWERLINK	
	1	RXD	Receive signal
	2	RXD\	Receive signal inverted
	3	TXD	Transmit signal
	4	Termination	Termination
	5	Termination	Termination
	6	TXD\	Transmit signal inverted
	7	Termination	Termination
	8	Termination	Termination

Table 38: POWERLINK interface - Pinout

2.4.7.2 Ethernet interface

Interface	Pinout		
Ethernet interface  Shielded RJ45 (10BASE-T /100BASE-TX)	Terminal	Ethernet	
	1	RXD	Receive signal
	2	RXD\	Receive signal inverted
	3	TXD	Transmit signal
	4	Termination	Termination
	5	Termination	Termination
	6	TXD\	Transmit signal inverted
	7	Termination	Termination
	8	Termination	Termination

Table 39: Ethernet interface - Pinout

2.4.7.3 USB interface

This Power Panel features a USB 2.0 (Universal Serial Bus) host controller with two USB interfaces that are accessible externally for the user.

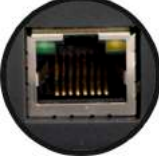

Figure 10: USB interface

USB interface	
Transfer rate ¹	Low speed (1.5 Mbit/s), full speed (12 Mbit/s), high speed (480 Mbit/s)
Power supply	Max. 0.49 A (IF3) or 0.10 A (IF4) per interface ²

Table 40: USB interface

- 1 The actual value depends on the operating system or driver being used.
- 2 Each USB interface is protected by a maintenance-free "USB current-limiting circuit breaker" (max. 0.49 A @ IF3 / max. 0.10 A @ IF4).

Warning!

Peripheral USB devices can be connected to the USB interfaces on this device. Due to the vast number of USB devices available on the market, B&R cannot guarantee their performance. All USB devices provided by B&R are guaranteed to function properly.

Important!

Because this interface is designed according to general PC specifications, extreme care should be exercised with regard to EMC, cable routing, etc.

2.4.7.4 X2X Link interface



Figure 11: X2X Link interface

Terminal	Pinout	
		X2X Link
1	X2X	X2X data
2	X2X _L	X2X ground
3	X2X _I	X2X data inverted
4	SHLD	Shield
Required accessories		
0TB5104.2110-01	Accessory terminal block, 4-pin (2.5), cage clamp, 0.5 mm ²	

Table 41: X2X Link interface

2.4.7.5 4PPC70.xxxx-21x - 2 CAN bus

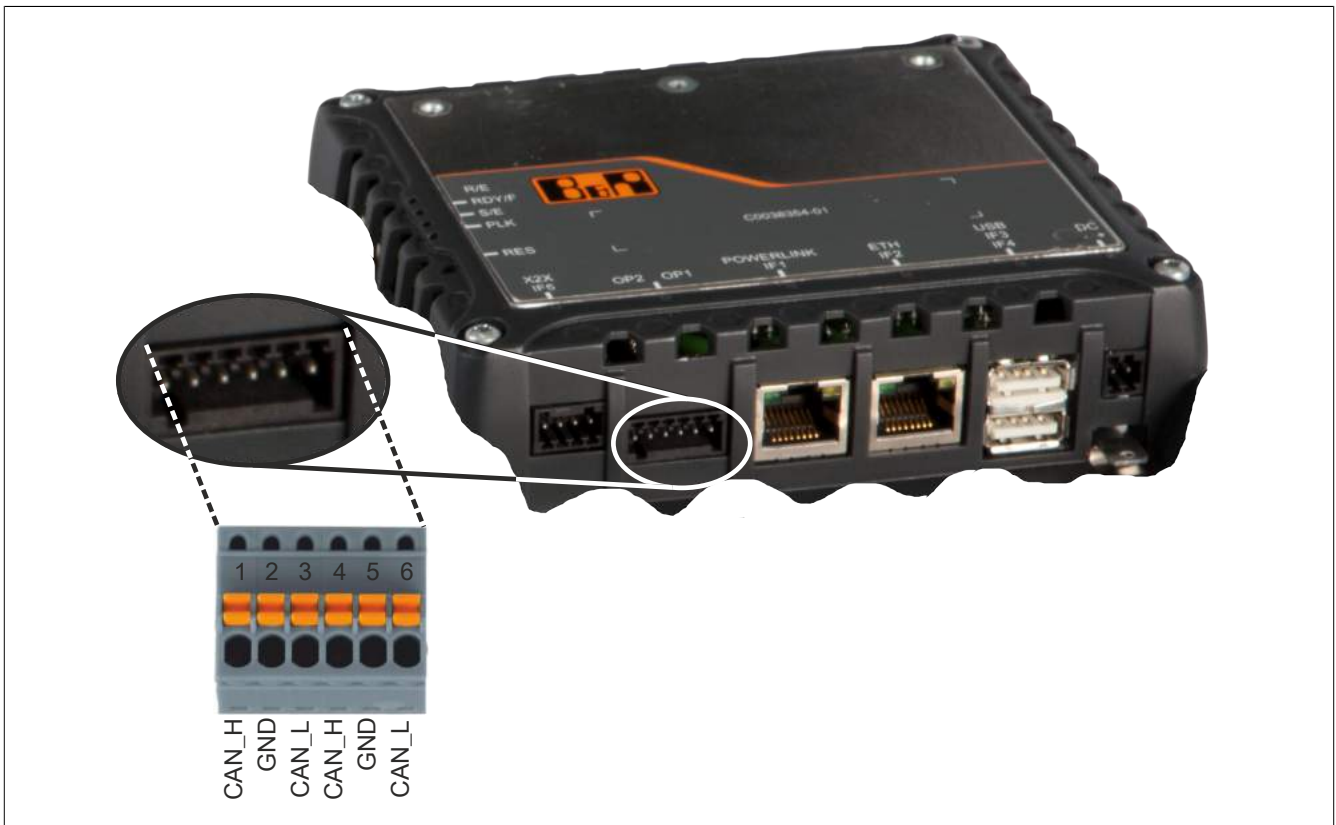

Figure 12: 4PPC70.xxxx-21x - 2 CAN bus

Terminal	Pinout	
	CAN bus	
1	CAN_H	CAN_High
2	GND	Ground
3	CAN_L	CAN_Low
4	CAN_H	CAN_High
5	GND	Ground
6	CAN_L	CAN_Low
Required accessories		
0TB5106.2110-01	Accessory terminal block, 6-pin (2.5), cage clamp, 0.5 mm ²	

Table 42: 4PPC70.xxxx-21x - 2 CAN bus

2.4.7.6 4PPC70.xxxx-22x - 1 CAN bus interface / 1 RS232 interface

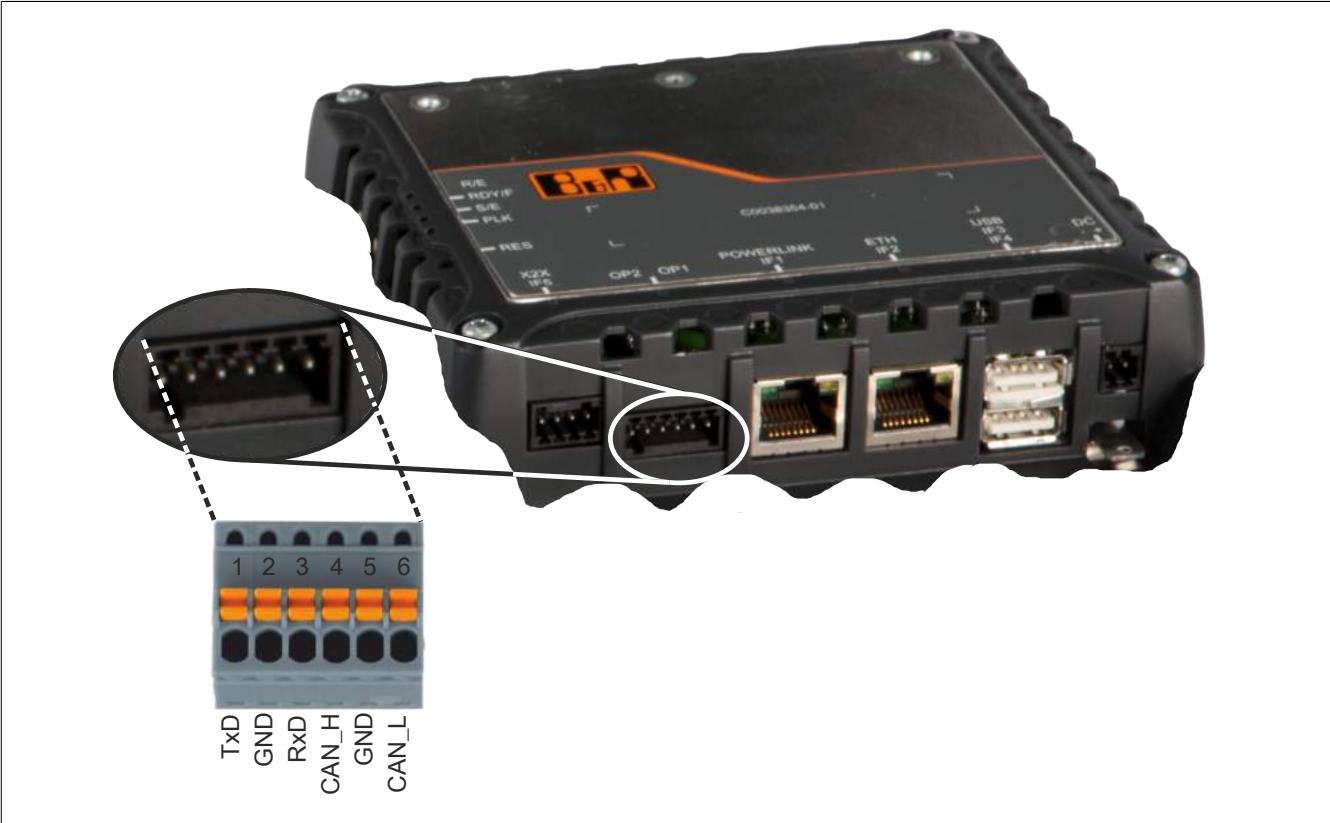

Figure 13: 4PPC70.xxxx-22x - 1 CAN bus interface / 1 RS232 interface

Terminal	Pinout	
RS232		
1	TxD	Transmit signal
2	GND	Ground
3	RxD	Receive signal
CAN bus		
4	CAN_H	CAN_High
5	GND	Ground
6	CAN_L	CAN_Low
Required accessories		
0TB5106.2110-01	Accessory terminal block, 6-pin (2.5), cage clamp, 0.5 mm²	

Table 43: 4PPC70.xxxx-22x - 1 CAN bus interface / 1 RS232 interface

2.4.7.7 4PPC70.xxxx-23x - 1 CAN bus interface / 1 RS485 interface

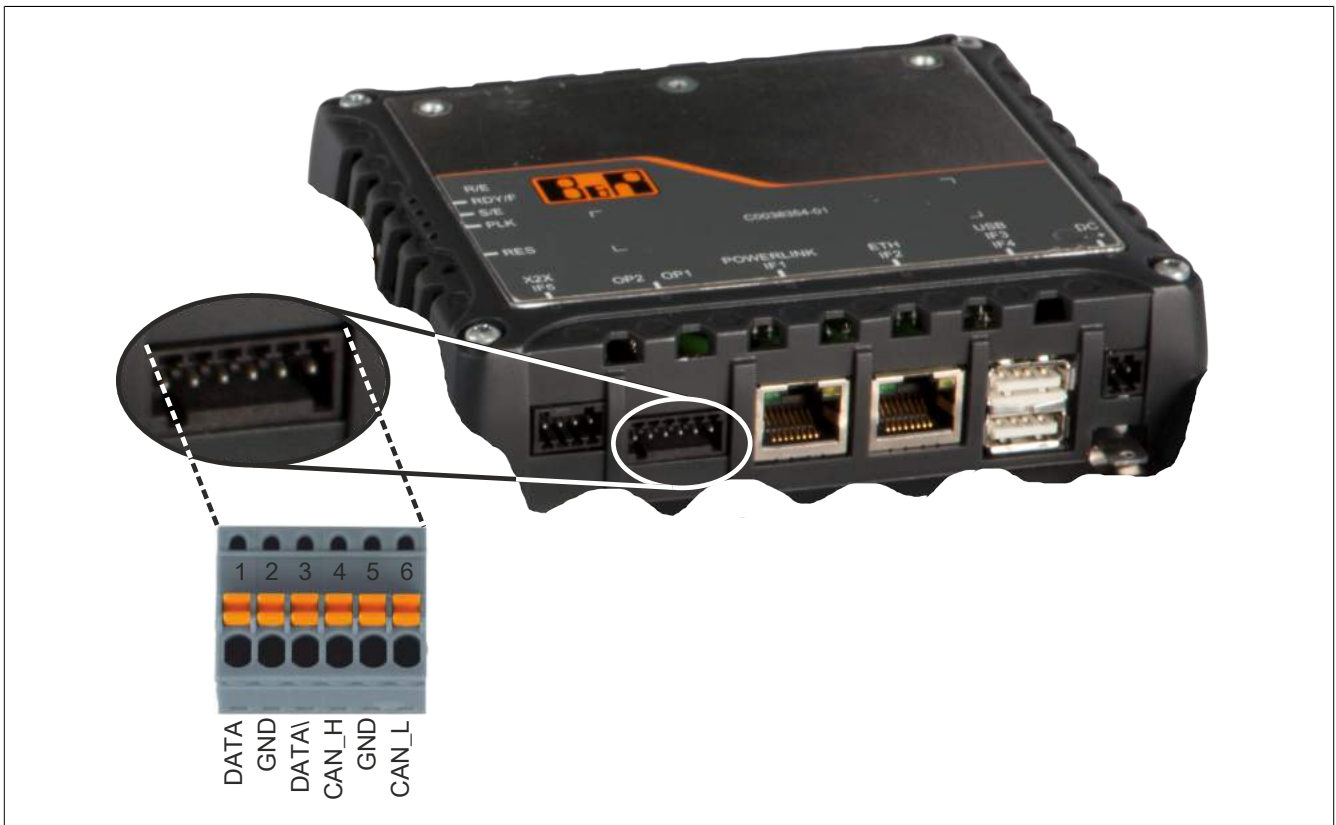

Figure 14: 4PPC70.xxxx-23x - 1 CAN bus interface / 1 RS485 interface

Terminal	Pinout	
	RS485	
1	DATA	Data
2	GND	Ground
3	DATA\	Data inverted
	CAN bus	
4	CAN_H	CAN_High
5	GND	Ground
6	CAN_L	CAN_Low
Required accessories		
0TB5106.2110-01	Accessory terminal block, 6-pin (2.5), cage clamp, 0.5 mm ²	

Table 44: 4PPC70.xxxx-23x - 1 CAN bus interface / 1 RS485 interface

2.4.7.8 Power supply



Figure 15: Power supply

The pinout is listed in the following table and printed on the back of the Power Panel. The Power Panel has reverse polarity protection that prevents the supply voltage from being connected incorrectly and damaging the device. Overload protection must be provided by an external fuse (5 A, fast-acting).

Pinout		
Terminal	Assignment	
1	+	24 VDC
2	-	GND
Required accessories		
0TB6102.2010-01	Accessory terminal block, 2-pin (3.81), screw clamp 1.5 mm ²	
0TB6102.2110-01	Accessory terminal block, 2-pin (3.81), cage clamp, 1.5 mm ²	

Table 45: Power supply

Important!

The ground potential (which has a spade terminal) must be connected to ground (e.g. control cabinet) using the shortest possible path.

2.4.8 Dimensions

2.4.8.1 Dimensions - 4PPC70.057x-2xx

Landscape

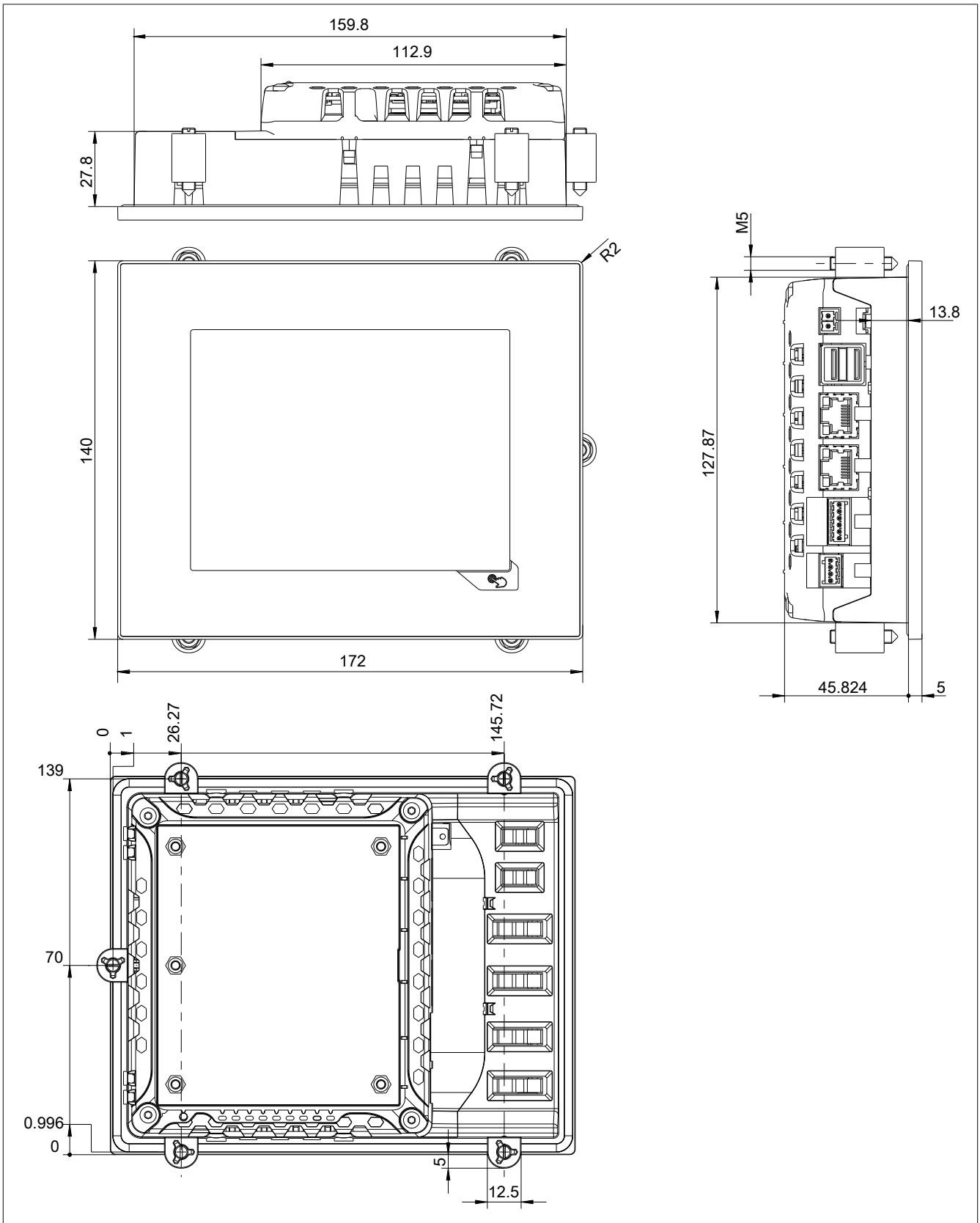

Max. control cabinet thickness: 6 mm

Cutout dimensions: 161.8 mm \pm 1 x 129.9 mm \pm 1

Portrait

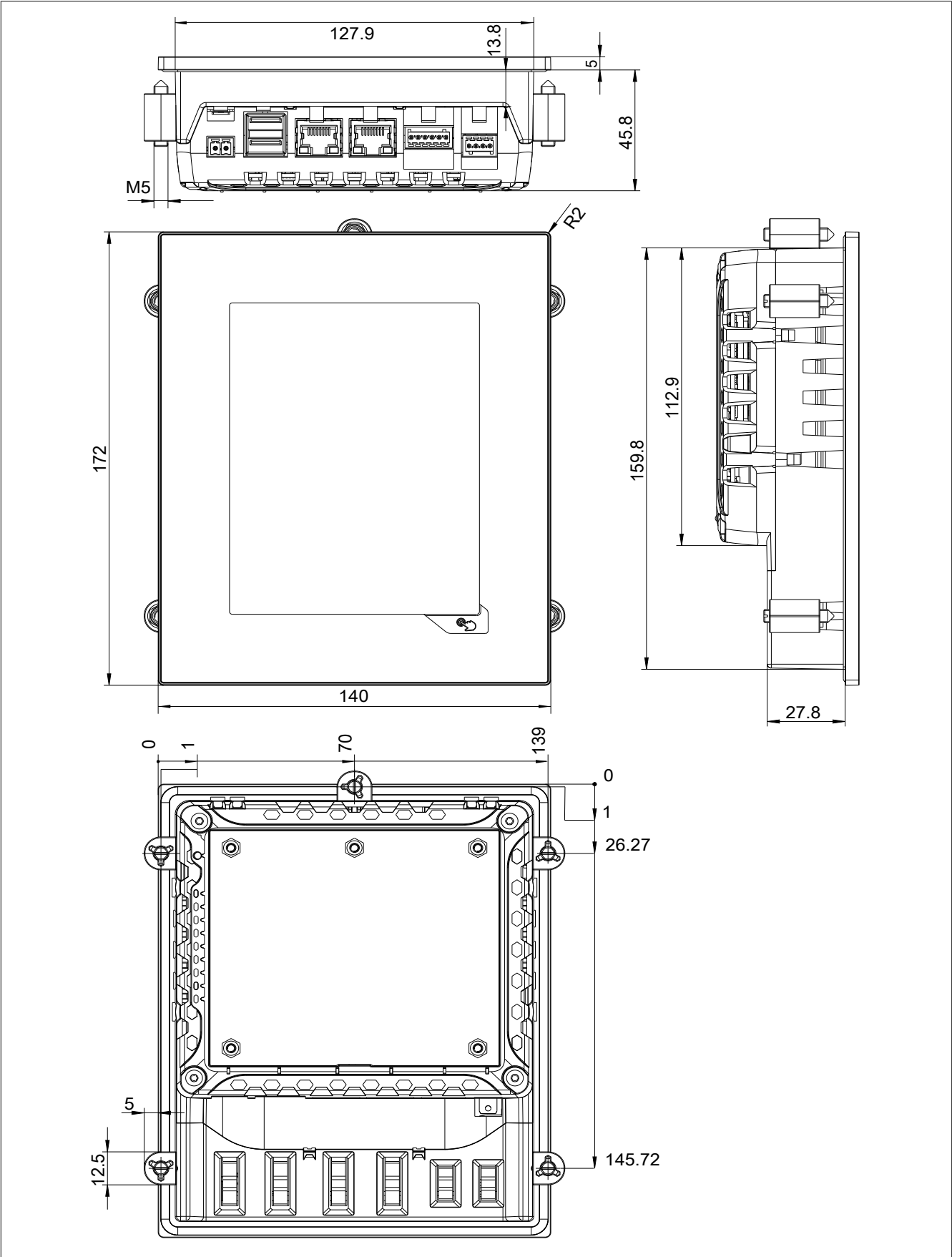

Figure 17: Dimensions - 4PPC70.057x-2xx - 4PPC70.057L

Max. control cabinet thickness: 6 mm

Cutout dimensions: 129.9 mm ±1 x 161.8 mm ±1

2.4.8.2 Dimensions - 4PPC70.070x-2xx

Landscape

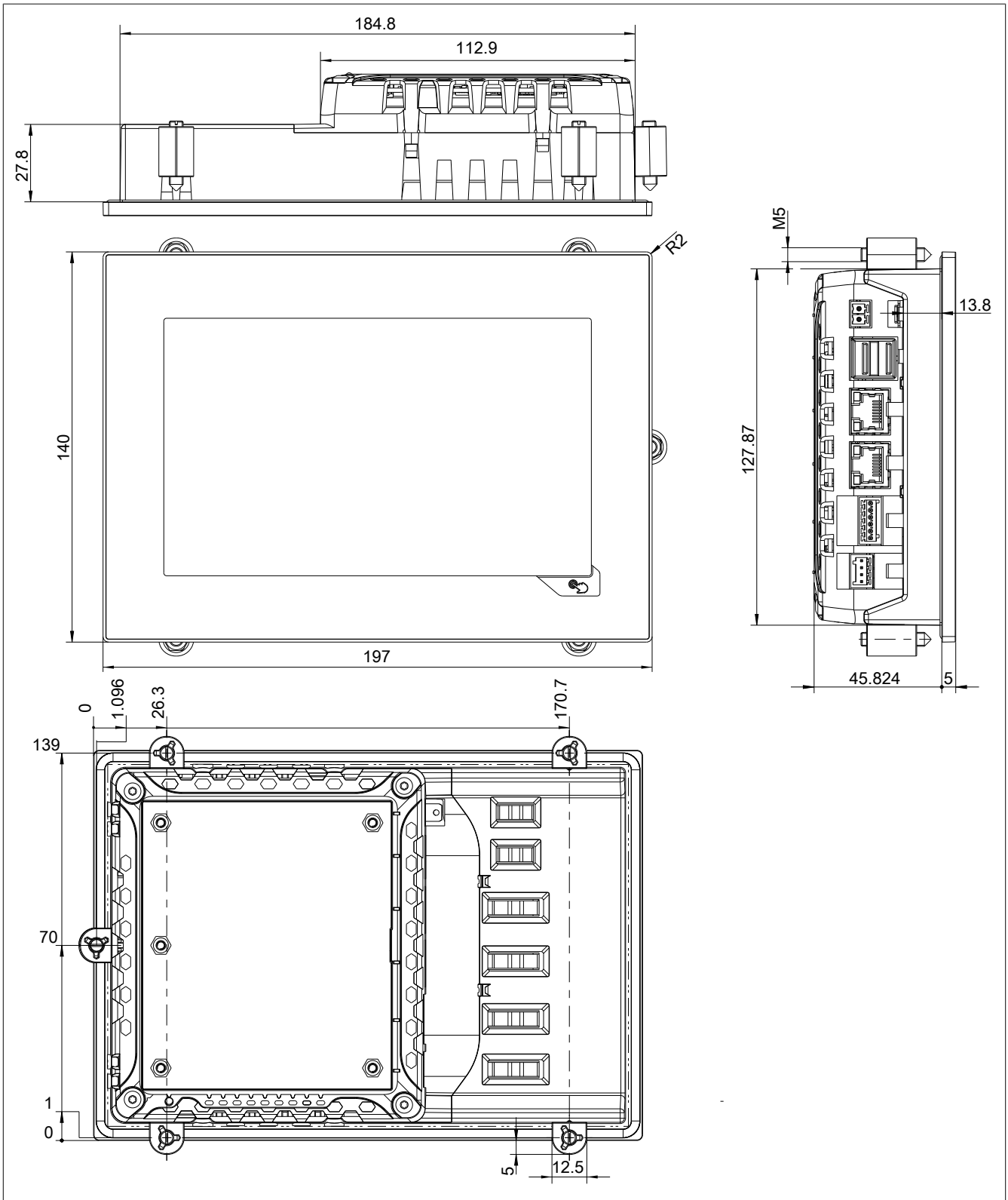

Figure 18: Dimensions - 4PPC70.070x-2xx - 4PPC70.0702

Max. control cabinet thickness: 6 mm

Cutout dimensions: 186.8 mm ±1 x 129.9 mm ±1

Portrait

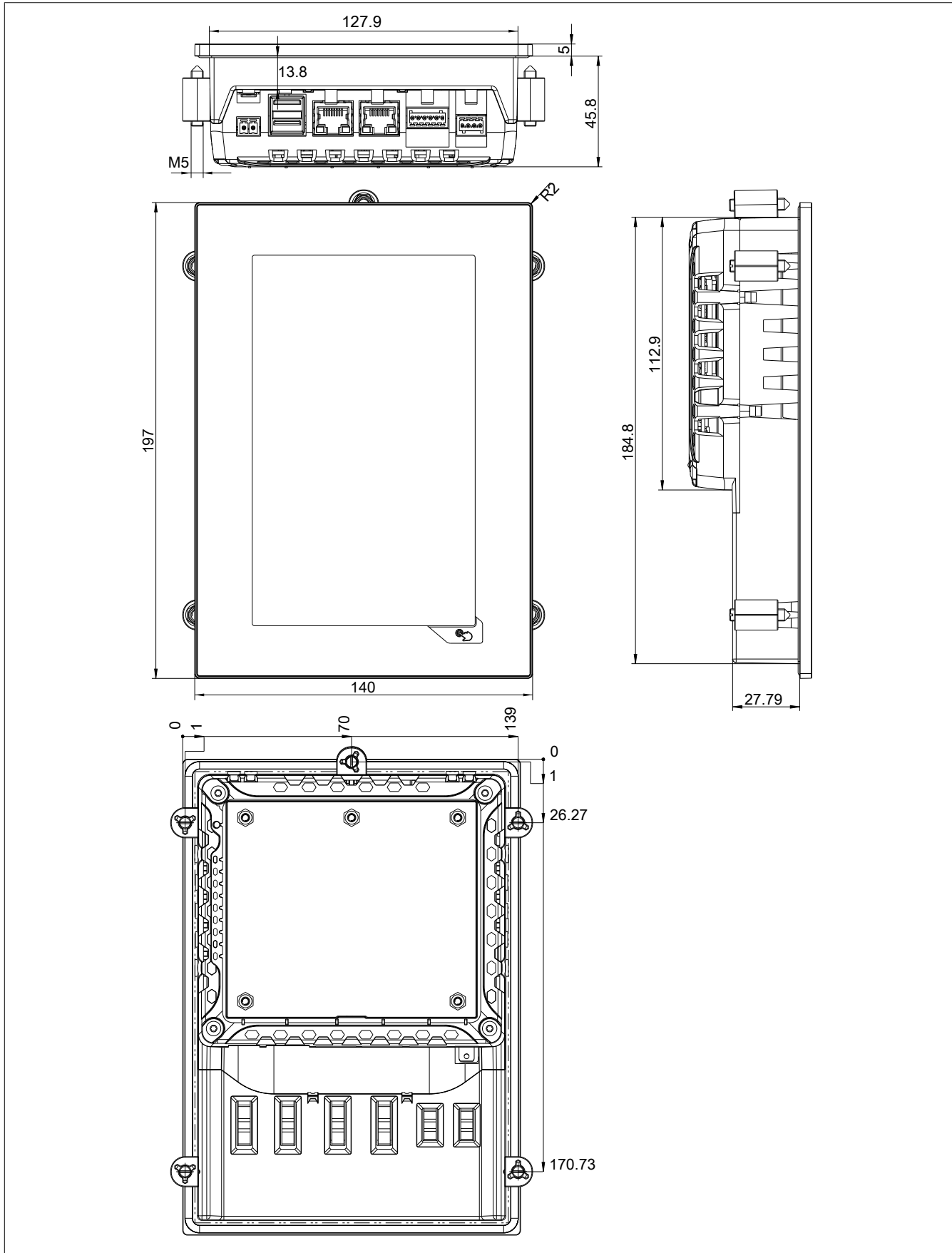
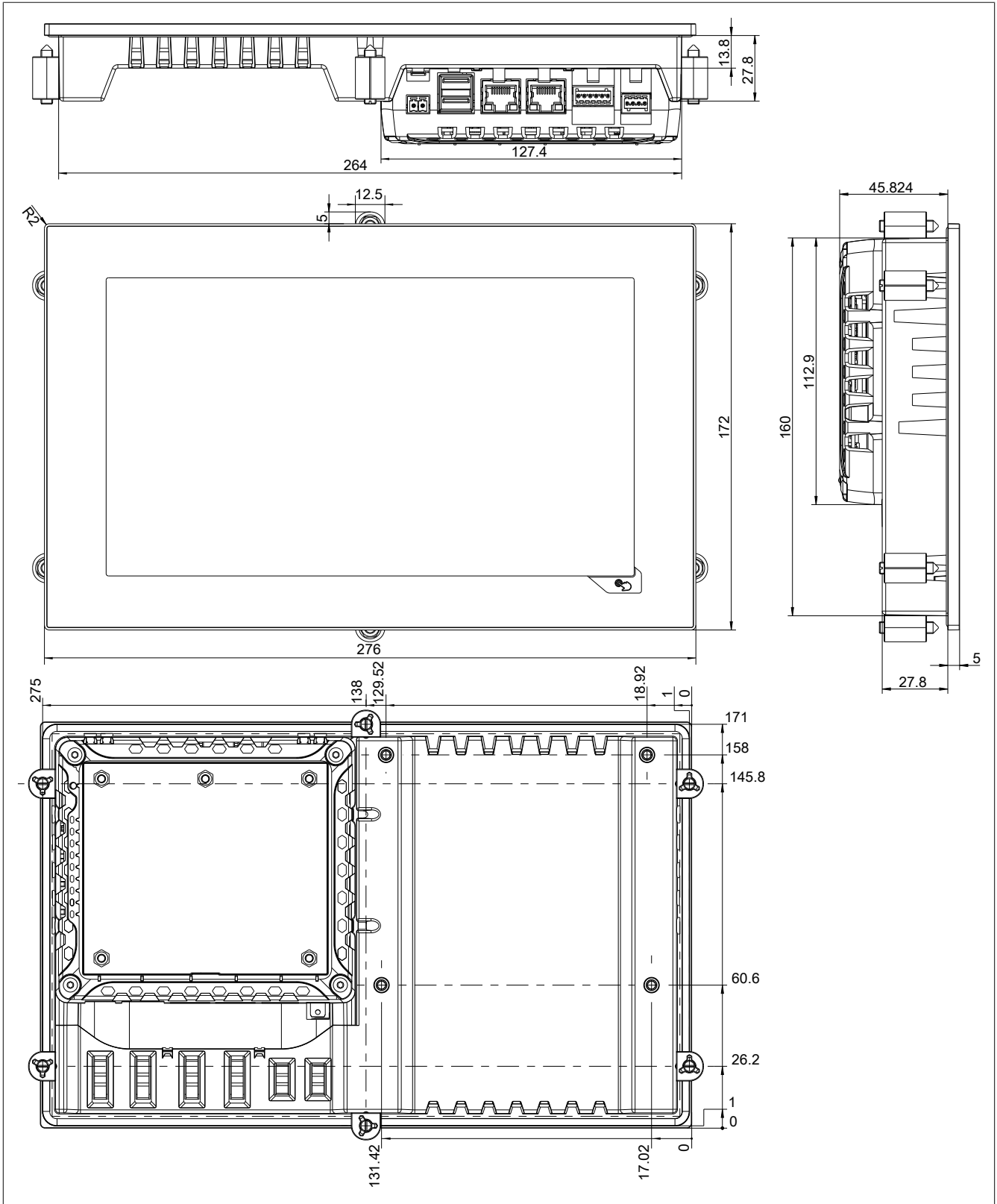

Figure 19: Dimensions - 4PPC70.070x-2xx - 4PPC70.070M

Max. control cabinet thickness: 6 mm
Cutout dimensions: 129.9 mm ±1 x 186.8 mm ±1

2.4.8.3 Dimensions - 4PPC70.101x-2xx

Landscape



Max. control cabinet thickness: 6 mm

Cutout dimensions: 265.9 mm ±1 x 161.9 mm ±1

Portrait

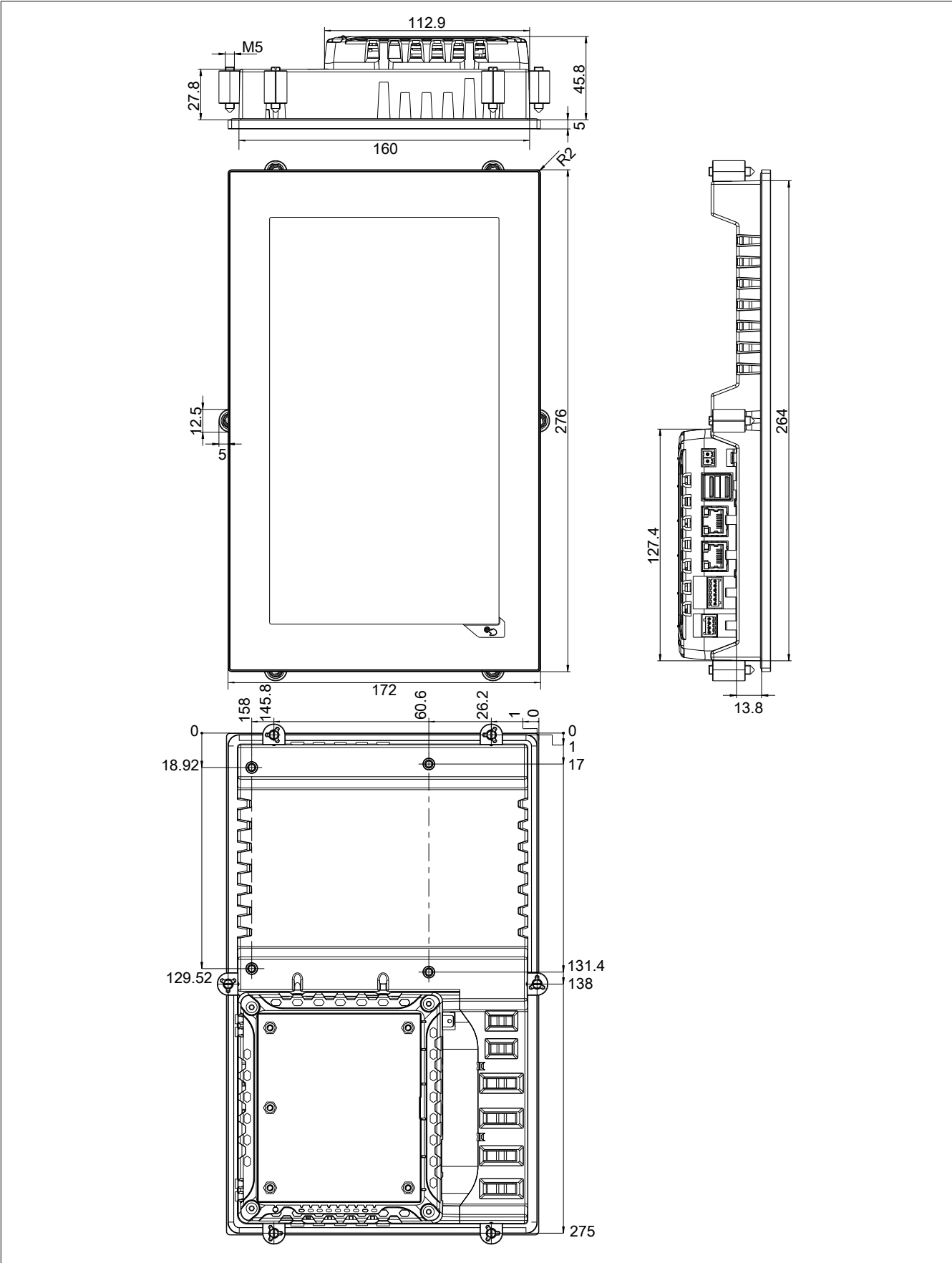

Figure 21: Dimensions - 4PPC70.101x-2xx - 4PPC70.101N

Max. control cabinet thickness: 6 mm
Cutout dimensions: 161.9 mm ±1 x 265.9 mm ±1

Chapter 3 • Installation

1 Installation instructions

The Power Panel must be mounted using the retaining clips included in delivery (with a torque of 0.6 Nm).

In order to guarantee sufficient air circulation, the specified amount of space above, below, to the side and behind the Power Panel must be provided. The minimum specified spacing is indicated in the following diagrams. This applies to all Power Panel variants.

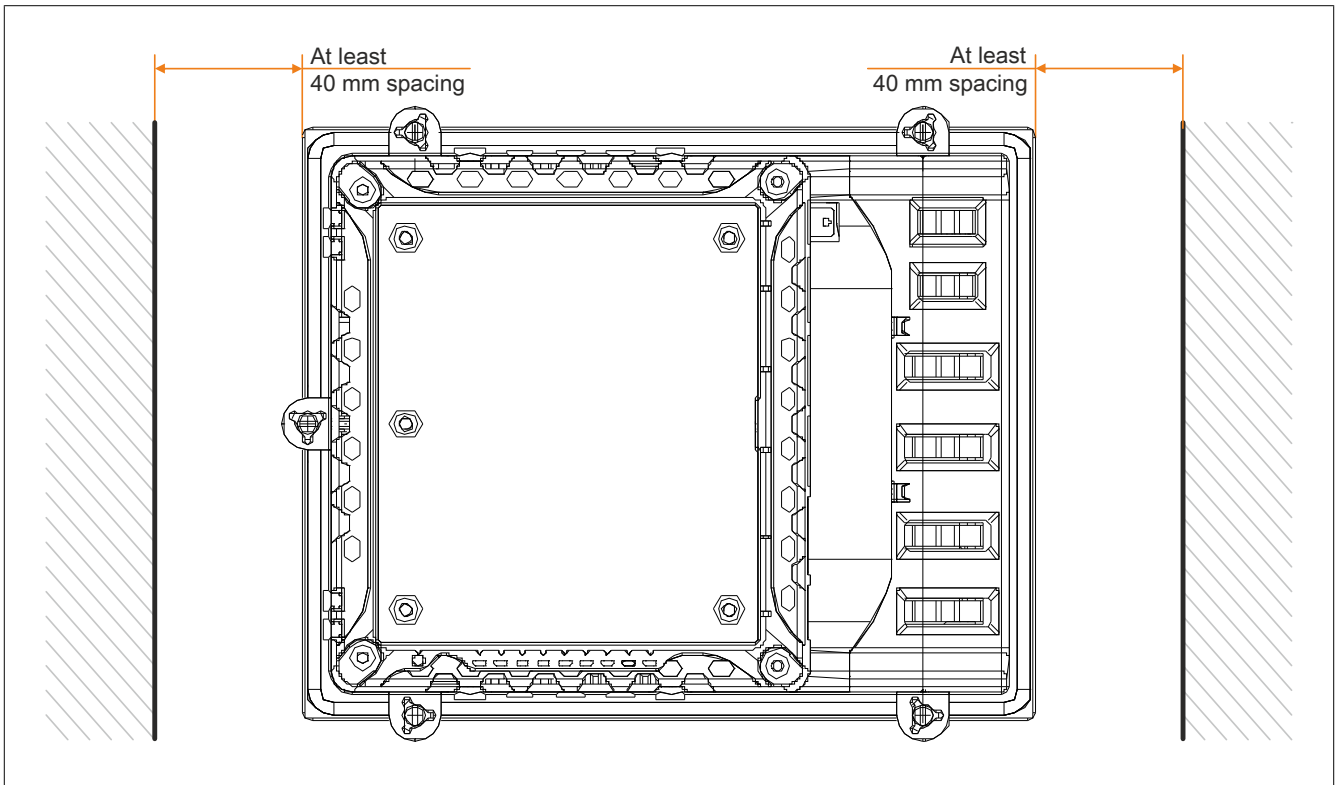

Figure 22: Spacing for air circulation - Rear view

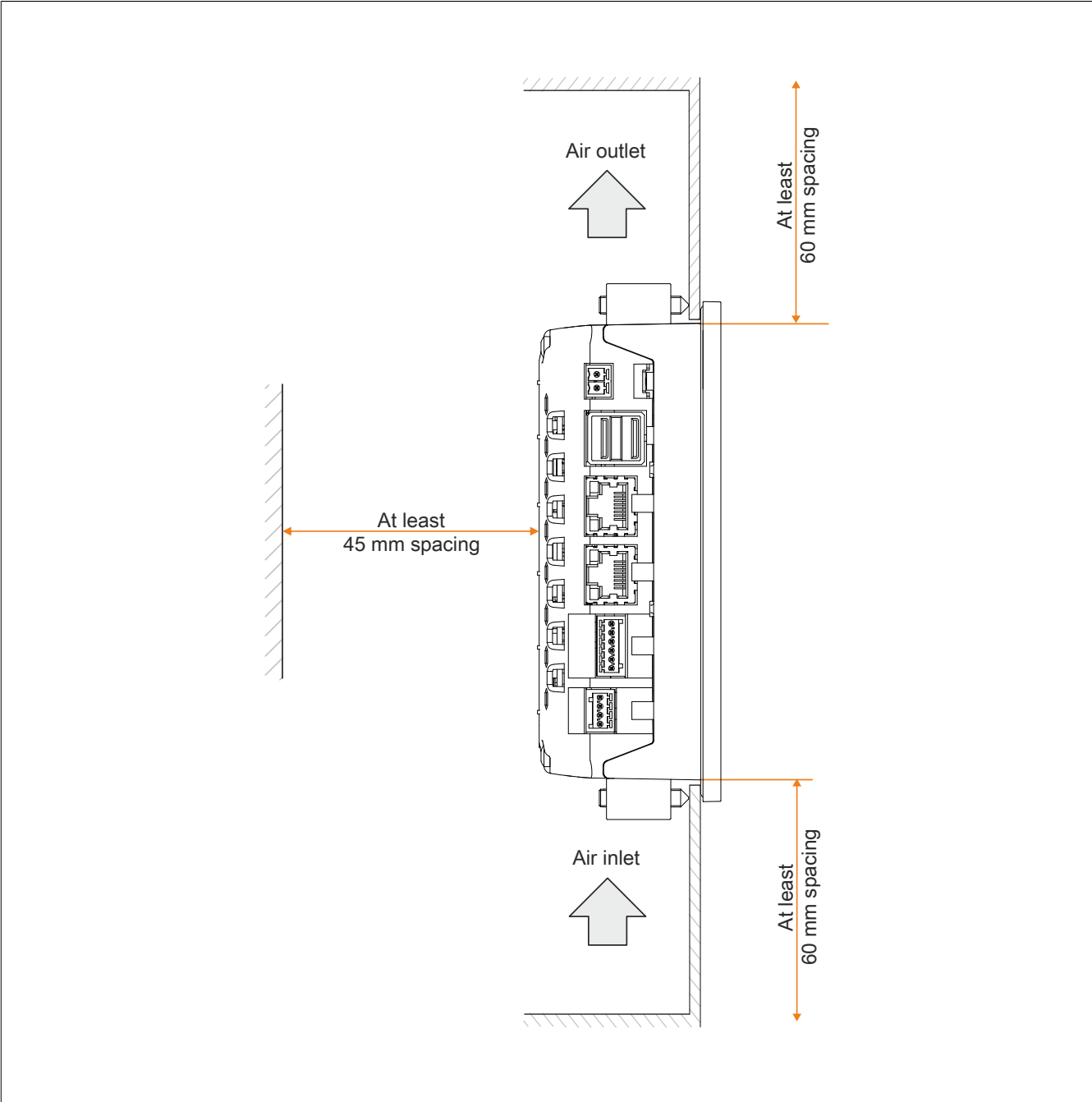

Figure 23: Spacing for air circulation - Side view

2 Mounting orientations

The following diagram shows the approved mounting orientations for Power Panel devices. These mounting orientations apply to all Power Panel variants.

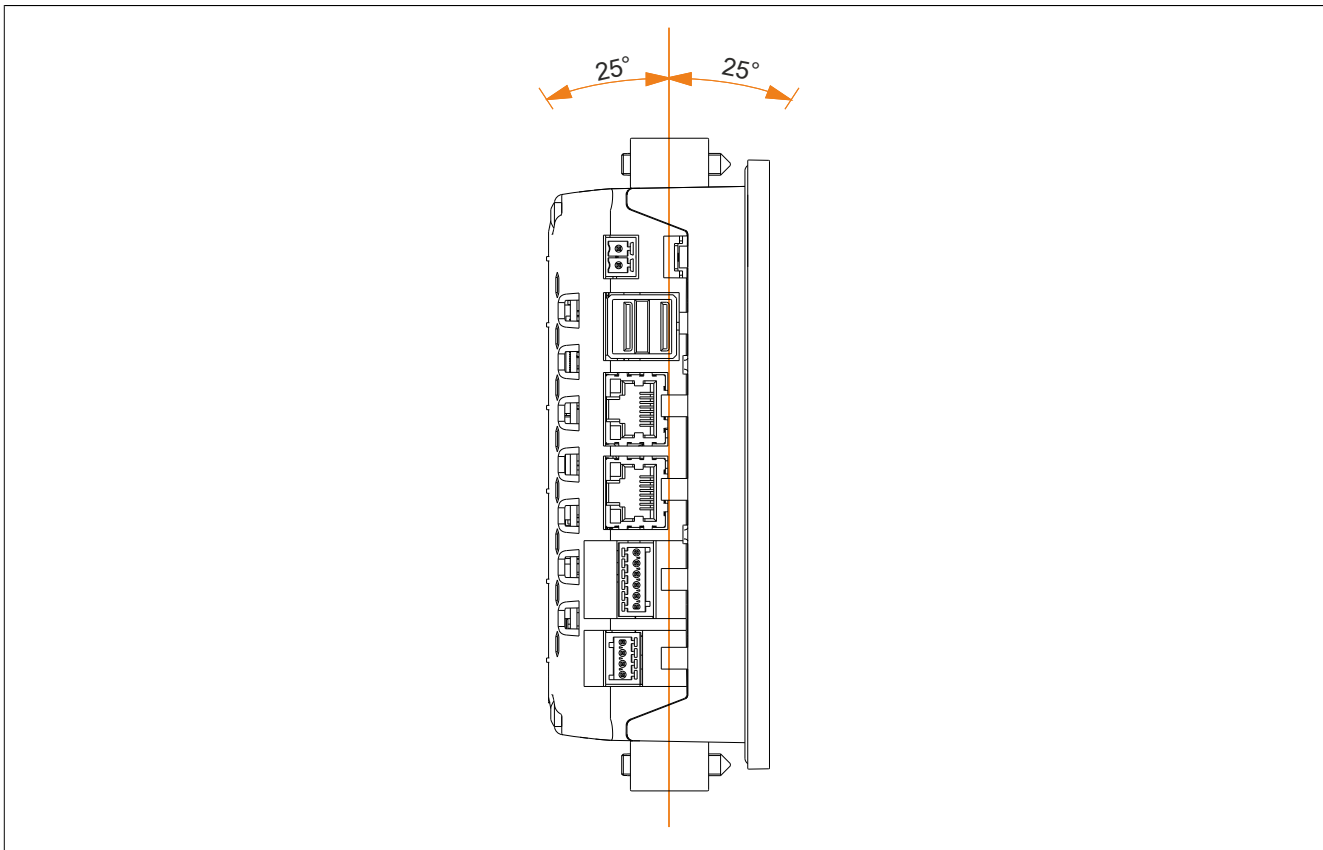

Figure 24: Power Panel - Mounting orientations

Caution!

The maximum permitted ambient temperature can be found in the technical data for the respective Power Panel device.

3 Commissioning

The Power Panel comes with Automation Runtime as default. Automation Runtime must first be installed in order to be able to operate the Power Panel. There are 3 methods available:

- AR transfer over the network with DHCP server
- AR transfer over the network without DHCP server
- USB stick - remote install structure

AR transfer over the network with DHCP server

See the AS help documentation

AR transfer over the network without DHCP server

- Connect the Power Panel to the network
- Start the Power Panel
- Create a new project with Power Panel in Automation Studio
- Open the browse dialog box in online settings
- Right-click on Power Panel with IP 0.0.0.0 and select "Set IP Parameters"
- The settings can be taken from the following example:

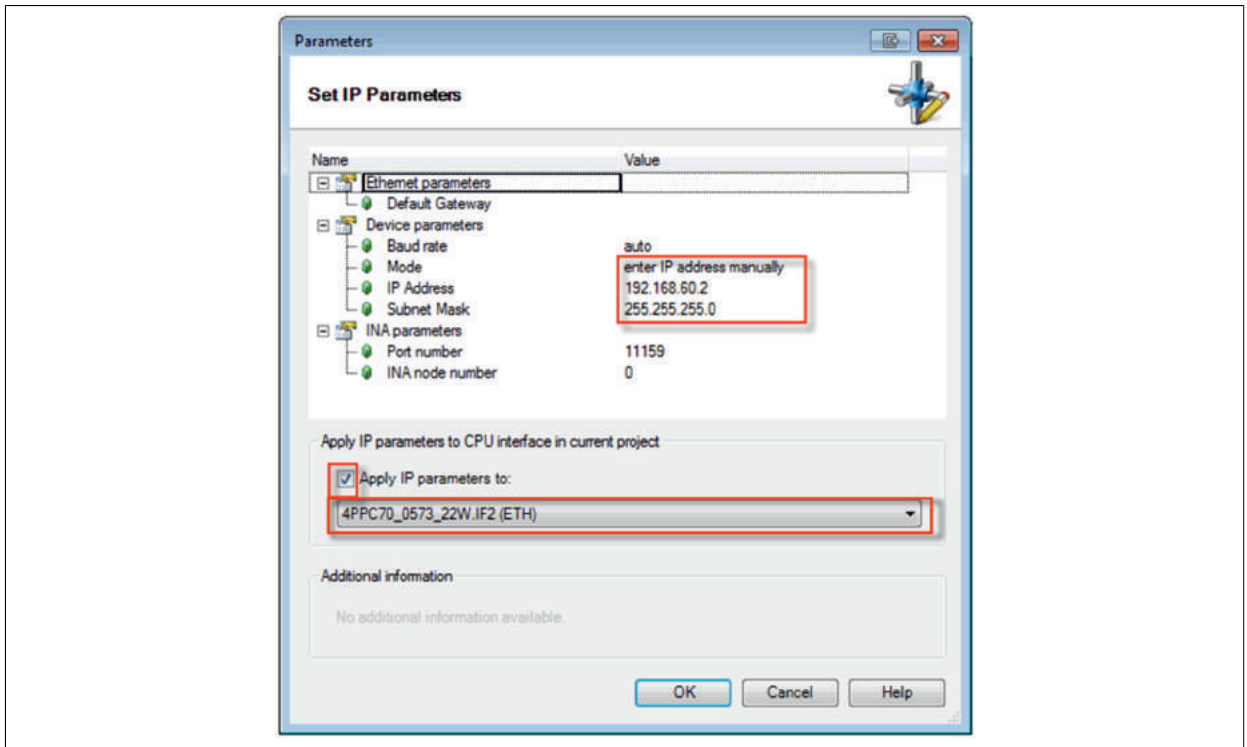

Figure 25: "Set IP Parameters" example

- Perform a "Rebuild" in Automation Studio (see image)



Figure 26: Performing a "Rebuild"

- After the "Rebuild" has been finished, select the function "Transfer Automation Runtime" in online services.
- In the "Operating System Transfer" window, mark the following setting, select "Next" and perform "Operating System Transfer"

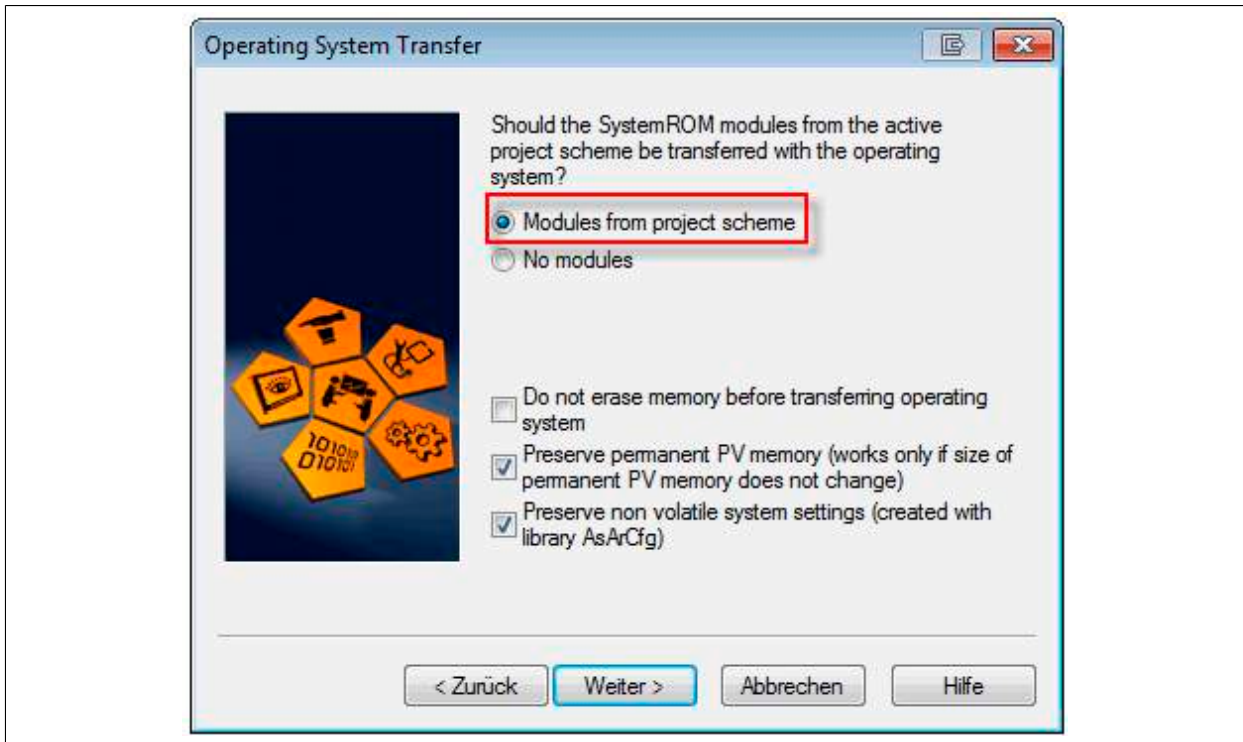

Figure 27: "Operating System Transfer" - Settings

Information:

First of all, in "Operating System Transfer" the memory is deleted, then Automation Runtime is transferred and after 3 automatic restarts the Power Panel is then in RUN mode.

USB stick - remote install structure

See details in the RUC (Runtime Utility Center) documentation.

4 Grounding

Grounding tongues on the circuit board ensure effective prevention of signal interference. The shielding of the various cables (X2X, POWERLINK, Ethernet, option board) is connected to the grounding plate.



Figure 28: Grounding

5 Touch screen

5.1 Touch screen calibration

B&R touch screen devices are equipped with a touch controller that supports hardware calibration. As a result, devices are pre-calibrated when delivered. This is an advantageous feature when replacing devices of the same model or type since it avoids having to recalibrate the new device. Nevertheless, calibrating the device is still recommended in order to achieve the best results and to better adapt the touch screen to the user's preferences.

5.2 Operating the touch screen

The analog resistive touch screen is executed about 1 cm over the edge of the display. If you press on 2 positions simultaneously, then the midpoint of the touch screen is controlled and selected.

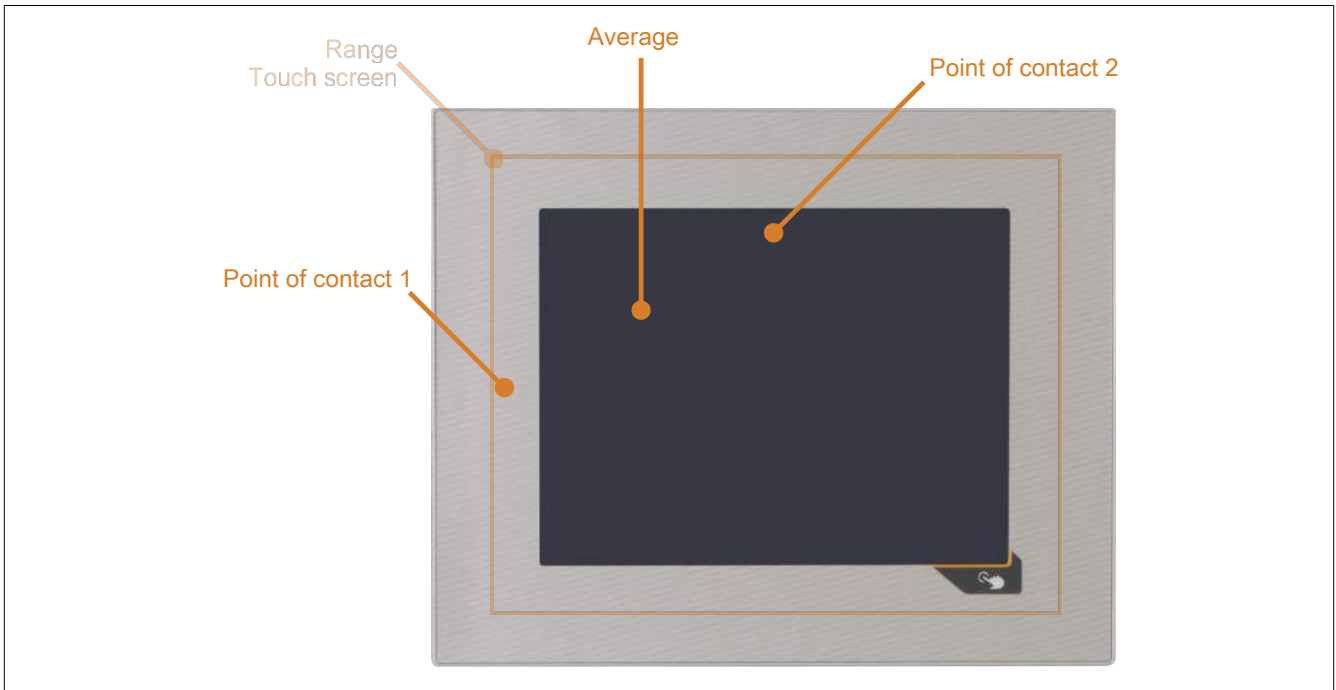

Figure 29: The midpoint between 2 points of contact

Note:

The touch screen goes beyond the inner edge of the panel overlay. When operating the touch screen, the selection is moved if the Power Panel is held in your hands and the panel overlay is touched.

6 Screen rotation

It is possible to rotate the contents of the screen by 90° using the graphic driver's screen rotation function. This function is supported by Automation Runtime.

Chapter 4 • Standards and certifications

1 Applicable European directives

- EMC directive 89/336/EEC
- Low-voltage directive 73/23/EEC
- Machine directive 98/37/EC

2 Overview of standards

Standard	Description
IEC 61131-2	Programmable logic controllers - Part 2: Equipment requirements and tests
EN 61000-6-2	Electromagnetic compatibility (EMC) - Part 2 - Generic standards - Immunity for industrial environments
EN 61000-6-4	Electromagnetic compatibility (EMC) - Part 2 - Generic standards - Emission standard for industrial environments
EN 50581	Technical documentation for the assessment of electrical and electronic products with respect to the restriction of hazardous substances (RoHS)
EN 60529	Degrees of protection provided by enclosures (IP code)
GOST-R	Certificate of conformity for Russia

Table 46: Overview of standards

3 International certifications

B&R products and services comply with applicable standards. This includes international standards from organizations such as ISO, IEC and CENELEC, as well as national standards from organizations such as UL, CSA, VDE, ÖVE, etc. We are committed to ensuring the reliability of our products in an industrial environment.

Certifications	
Europe 	This mark certifies that all harmonized EN standards for the applicable directives have been met.

Table 47: International certifications

Chapter 5 • Accessories

1 Overview

Model number	Product ID	4PPC70.057x-20X	4PPC70.070x-20X	4PPC70.101x-20X	4PPC70.057x-21X	4PPC70.070x-21X	4PPC70.101x-21X	4PPC70.057x-22X	4PPC70.070x-22X	4PPC70.101x-22X	4PPC70.057x-23X	4PPC70.070x-23X	4PPC70.101x-23X	Page
Cage clamp terminal block														
0TB6102.2110-01	Accessory 2-pin cage clamp (3.81)	•	•	•	•	•	•	•	•	•	•	•	•	86
0TB5104.2110-01	Accessory 4-pin cage clamp (2.5)	•	•	•	•	•	•	•	•	•	•	•	•	
0TB5106.2110-01	Accessory 6-pin cage clamp (2.5)				•	•	•	•	•	•	•	•	•	
Screw clamp terminal block														
0TB6102.2010-01	Accessory 2-pin screw clamp (3.81)	•	•	•	•	•	•	•	•	•	•	•	•	86
USB accessories														
5MMUSB.2048-01	USB 2.0 flash drive, 2048 MB, B&R	•	•	•	•	•	•	•	•	•	•	•	•	87
5MMUSB.4096-01	USB 2.0 flash drive, 4096 MB, B&R	•	•	•	•	•	•	•	•	•	•	•	•	
POWERLINK cable, RJ45 to RJ45														
X20CA0E61.00020	PLK connection cable, RJ45 to RJ45, 0.20 m	•	•	•	•	•	•	•	•	•	•	•	•	87
X20CA0E61.00025	PLK connection cable, RJ45 to RJ45, 0.25 m	•	•	•	•	•	•	•	•	•	•	•	•	
X20CA0E61.00030	PLK connection cable, RJ45 to RJ45, 0.30 m	•	•	•	•	•	•	•	•	•	•	•	•	
X20CA0E61.00035	PLK connection cable, RJ45 to RJ45, 0.35 m	•	•	•	•	•	•	•	•	•	•	•	•	
X20CA0E61.00040	PLK connection cable, RJ45 to RJ45, 0.40 m	•	•	•	•	•	•	•	•	•	•	•	•	
X20CA0E61.00050	PLK connection cable, RJ45 to RJ45, 0.50 m	•	•	•	•	•	•	•	•	•	•	•	•	
X20CA0E61.00100	PLK connection cable RJ45 to RJ45, 1 m	•	•	•	•	•	•	•	•	•	•	•	•	
X20CA0E61.00150	PLK connection cable, RJ45 to RJ45, 1.50 m	•	•	•	•	•	•	•	•	•	•	•	•	
X20CA0E61.00200	PLK connection cable RJ45 to RJ45, 2 m	•	•	•	•	•	•	•	•	•	•	•	•	
X20CA0E61.00300	PLK connection cable RJ45 to RJ45, 3 m	•	•	•	•	•	•	•	•	•	•	•	•	
X20CA0E61.00500	PLK connection cable RJ45 to RJ45, 5 m	•	•	•	•	•	•	•	•	•	•	•	•	
X20CA0E61.00800	PLK connection cable RJ45 to RJ45, 8 m	•	•	•	•	•	•	•	•	•	•	•	•	
X20CA0E61.01000	PLK connection cable RJ45 to RJ45, 10 m	•	•	•	•	•	•	•	•	•	•	•	•	
X20CA0E61.01200	PLK connection cable RJ45 to RJ45, 12 m	•	•	•	•	•	•	•	•	•	•	•	•	
X20CA0E61.01500	PLK connection cable RJ45 to RJ45, 15 m	•	•	•	•	•	•	•	•	•	•	•	•	
X20CA0E61.02000	PLK connection cable RJ45 to RJ45, 20 m	•	•	•	•	•	•	•	•	•	•	•	•	
X20CA0E61.03000	PLK connection cable RJ45 to RJ45, 30 m	•	•	•	•	•	•	•	•	•	•	•	•	
X20CA0E61.05000	PLK connection cable RJ45 to RJ45, 50 m	•	•	•	•	•	•	•	•	•	•	•	•	
X20CA0E61.06000	PLK connection cable RJ45 to RJ45, 60 m	•	•	•	•	•	•	•	•	•	•	•	•	
POWERLINK cables, RJ45 to RJ45, can be used in cable drag chains														
X20CA3E61.0100	PLK connection cable, RJ45-RJ45, drag chain, 10 m	•	•	•	•	•	•	•	•	•	•	•	•	87
X20CA3E61.0150	PLK connection cable, RJ45-RJ45, drag chain, 15 m	•	•	•	•	•	•	•	•	•	•	•	•	
X20CA3E61.0200	PLK connection cable, RJ45-RJ45, drag chain, 0.20 m	•	•	•	•	•	•	•	•	•	•	•	•	
POWERLINK cables, RJ45 to M12														
X67CA0E41.0010	PLK attachment cable RJ45 to M12, 1 m	•	•	•	•	•	•	•	•	•	•	•	•	87
X67CA0E41.0050	PLK attachment cable RJ45 to M12, 5 m	•	•	•	•	•	•	•	•	•	•	•	•	
X67CA0E41.0150	PLK attachment cable RJ45 to M12, 15 m	•	•	•	•	•	•	•	•	•	•	•	•	
X67CA0E41.0500	PLK attachment cable RJ45 to M12, 50 m	•	•	•	•	•	•	•	•	•	•	•	•	
POWERLINK cable, RJ45 to M12, can be used in cable drag chains														
X67CA3E41.0150	PLK attachment cable RJ45-M12, drag chain, 15 m	•	•	•	•	•	•	•	•	•	•	•	•	87
X2X Link cables, straight														
X67CA0X21.0005	X2X Link attachment cable, 0.50 m	•	•	•	•	•	•	•	•	•	•	•	•	87
X67CA0X21.0020	X2X Link attachment cable, 2 m	•	•	•	•	•	•	•	•	•	•	•	•	
X67CA0X21.0030	X2X Link attachment cable, 3 m	•	•	•	•	•	•	•	•	•	•	•	•	
X67CA0X21.0050	X2X Link attachment cable, 5 m	•	•	•	•	•	•	•	•	•	•	•	•	
X67CA0X21.0100	X2X Link attachment cable, 10 m	•	•	•	•	•	•	•	•	•	•	•	•	
X67CA0X21.0150	X2X Link attachment cable, 15 m	•	•	•	•	•	•	•	•	•	•	•	•	
X67CA0X21.0200	X2X Link attachment cable, 20 m	•	•	•	•	•	•	•	•	•	•	•	•	
X67CA0X21.0500	X2X Link attachment cable, 50 m	•	•	•	•	•	•	•	•	•	•	•	•	
X2X Link cables, angled														
X67CA0X31.0020	X2X Link attachment cable, angled, 2 m	•	•	•	•	•	•	•	•	•	•	•	•	87
X67CA0X31.0040	X2X Link attachment cable, angled, 4 m	•	•	•	•	•	•	•	•	•	•	•	•	
X67CA0X31.0050	X2X Link attachment cable, angled, 5 m	•	•	•	•	•	•	•	•	•	•	•	•	
X67CA0X31.0100	X2X Link attachment cable, angled, 10 m	•	•	•	•	•	•	•	•	•	•	•	•	
X67CA0X31.0150	X2X Link attachment cable, angled, 15 m	•	•	•	•	•	•	•	•	•	•	•	•	

Table 48: C-Series overview

Model number	Product ID	4PPC70.057x-20x	4PPC70.070x-20x	4PPC70.101x-20x	4PPC70.057x-21x	4PPC70.070x-21x	4PPC70.101x-21x	4PPC70.057x-22x	4PPC70.070x-22x	4PPC70.101x-22x	4PPC70.057x-23x	4PPC70.070x-23x	4PPC70.101x-23x	Page
X67CA0X31.0500	X2X Link attachment cable, angled, 50 m	•	•	•	•	•	•	•	•	•	•	•	•	
X2X Link cable														
X67CA0X99.1000	Cable for custom assembly, 100 m	•	•	•	•	•	•	•	•	•	•	•	•	87
X67CA0X99.5000	Cable for custom assembly, 500 m	•	•	•	•	•	•	•	•	•	•	•	•	

Table 48: C-Series overview

2 TB102 2-pin power supply connector

This single-row 2-pin terminal block is used to connect the power supply.

2.1 Order data

Model number	Short description	Figure
	Terminal blocks	
0TB6102.2010-01	Accessory terminal block, 2-pin (3.81), screw clamp 1.5 mm ²	
0TB6102.2110-01	Accessory terminal block, 2-pin (3.81), cage clamp, 1.5 mm ²	

Table 49: 0TB6102.2010-01, 0TB6102.2110-01 - Order data

2.2 Technical data

Information:

The following characteristics, features and limit values only apply to this accessory and can deviate from those specified for the complete system. The data specifications for the complete system take precedence over those of individual components.

The technical data in this manual is current as of its creation/publication. We reserve the right to make changes.

Product ID	0TB6102.2010-01	0TB6102.2110-01
Terminal block		
Number of pins	2 (female)	
Type of terminal clamp	Screw clamps	Cage clamps
Cable type	Copper wires only (no aluminum wires!)	
Distance between contacts	3.81 mm	
Connection cross section		
AWG wire	28 to 16	
Wire end sleeves with plastic covering	0.25 to 0.5 mm ²	
With wire end sleeves	0.25 to 1.5 mm ²	
Flexible	0.14 to 1.5 mm ²	
Inflexible	0.14 to 1.5 mm ²	
Tightening torque	0.22 to 0.25 Nm	-
Electrical characteristics		
Nominal voltage	300 V	
Nominal current ¹⁾	8 A	

Table 50: 0TB6102.2010-01, 0TB6102.2110-01 - Technical data

1) The limit data for each Power Panel must be taken into consideration.

3 TB510x 4/6-pin terminal block

The single-row 4-pin terminal block is needed for the X2X Link interface. The single-row 6-pin terminal block is needed for the option board.

3.1 Order data



	
0TB5104.2110-01	0TB5106.2110-01
Model number	Short description
	Terminal blocks
0TB5104.2110-01	Accessory terminal block, 4-pin (2.5), cage clamp, 0.5 mm ²
0TB5106.2110-01	Accessory terminal block, 6-pin (2.5), cage clamp, 0.5 mm ²

Table 51: 0TB5104.2110-01, 0TB5106.2110-01 - Order data

3.2 Technical data

Information:

The following characteristics, features and limit values only apply to this accessory and can deviate from those specified for the complete system. The data specifications for the complete system take precedence over those of individual components.

The technical data in this manual is current as of its creation/publication. We reserve the right to make changes.

Product ID	0TB5104.2110-01	0TB5106.2110-01
Terminal block		
Number of pins	4	6
Type of terminal clamp	Cage clamps ¹⁾	Cage clamps
Cable type	Only copper wires (no aluminum wires!)	
Distance between contacts	2.5 mm	
Connection cross section		
AWG wire	26 to 20	
With wire end sleeves	0.25 to 0.5 mm ²	
Flexible	0.14 to 0.5 mm ²	
Inflexible	0.14 to 0.5 mm ²	
Electrical characteristics		
Nominal voltage	125 V	
Nominal current ²⁾	4 A	

Table 52: 0TB5104.2110-01, 0TB5106.2110-01 - Technical data

- 1) Cage clamp terminal blocks cannot be used side-by-side.
- 2) Take the respective limit data for the I/O modules into consideration!

4 Data storage media

Technical data and additional information about data storage media can be found in the respective documentation. This can be found and downloaded under the model number of the data storage medium at www.br-automation.com.

5 Cable accessories

Technical data and additional information about POWERLINK and X2X Link cables can be found in the respective documentation. This can be found and downloaded under the model number of the cable on the B&R website at www.br-automation.com.

Chapter 6 • Maintenance

1 Cleaning

Danger!

Power Panels may only be cleaned when switched off in order to prevent unintended functions from being triggered when handling the touch screen or pressing keys.

Power Panels should be cleaned with a moist cloth. The cloth should be moistened with water and detergent, a screen cleaning agent or alcohol (ethanol). The cleaning agent should be applied to the cloth beforehand, not sprayed directly on the Power Panel! Aggressive solvents, chemicals, scouring agents, pressurized air or steam jets should never be used.

Information:

Displays with a touch screen should be cleaned regularly.

2 Screen burn-in on LCD/TFT monitors

Screen burn-in (afterimages, display memory effect, image retention or image sticking) occurs on LCD/TFT displays if a static image is displayed for a prolonged period of time. This static screen content causes the build-up of parasitic capacitances within the LCD components that prevent liquid crystal molecules from returning to their original state. This condition is unpredictable and can depend on the following factors:

- Type of image displayed
- Color composition of the image
- Length of time that the image is displayed
- Ambient temperature

Preventing screen burn-in

There is no perfect solution. There are ways to significantly reduce this effect, however:

- Avoid static images or screen content.
- Use non-static screensavers when the display is not in use.
- Frequent picture change
- Turn off the display when not in use.

Turning off the backlight does not help prevent screen burn-in.

Chapter 7 • Technical information

1 Panel overlay

The panel overlay conforms to DIN 42115 (Part 2). This means it is resistant to exposure to the following chemicals for a 24-hour period with no visible signs of damage:

Information:

The following characteristics, features and limit values only apply to this individual component and can deviate from those specified for the complete system. For the complete system in which this individual component is used, refer to the data given specifically for that device.

Ethanol Cyclohexanol Diacetone alcohol Glycol Isopropanol Glycerine Methanol Triacetin Dowandol DRM/PM	Formaldehyde 37%-42% Acetaldehyde Aliphatic hydrocarbons Toluene Xylene White spirits	Trichloroethane Ethyl acetate Diethyl ether n-Butyl acetate Amyl acetate Butylcellosolve Ether
Acetone Methyl ethyl ketone Dioxan Cyclohexanone Methylisobutylketone (MIBK) Isophorone	Formic acid < 50% Acetic acid < 50% Phosphoric acid < 30% Hydrochloric acid < 36% Nitric acid < 10% Trichloroacetic acid < 50% Sulphuric acid < 10%	Sodium chloride <20% Hydrogen peroxide < 25% Potassium carbonate Washing agents Tenside Fabric conditioner Iron (II) chloride Iron (III) chloride Dibutyl phthalate Dioctyl phthalate Sodium carbonate
Ammonia < 40% Caustic soda < 40% Potassium hydroxide Alkali carbonate Bichromate Potassium Acetonitrile Sodium bisulphate	Cutting oil Diesel oil Linseed oil Paraffin oil Ricinus oil Silicon oil Turpentine oil substitute Brake fluid Aviation fuel Gasoline Water Sea water Decon	

Table 53: Chemical resistance of the panel overlay

The panel overlay conforms to DIN 42115 section 2 for exposure to glacial acetic acid for less than one hour without visible damage.

2 Viewing angles

Viewing angle specifications (R, L, U, D) for the display types are listed in the technical data for each device.

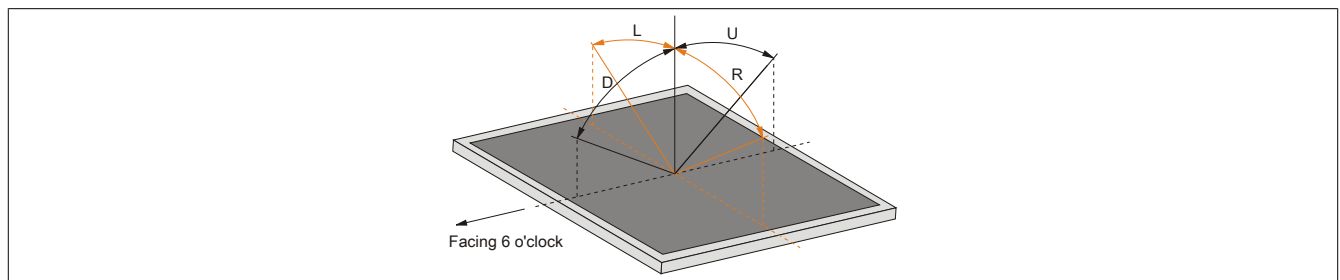

Figure 30: Viewing angles

Figure 1:	C-Series.....	7
Figure 2:	Power Panel C70.....	8
Figure 3:	Order number key.....	9
Figure 4:	Selecting a Power Panel.....	10
Figure 5:	Diagnostic LEDs.....	61
Figure 6:	Ethernet and POWERLINK LEDs.....	63
Figure 7:	4PPC70.057x-2xx - Temperature/Humidity diagram.....	64
Figure 8:	4PPC70.070x-2xx - Temperature/Humidity diagram.....	64
Figure 9:	4PPC70.101x-2xx - Temperature/Humidity diagram.....	65
Figure 10:	USB interface.....	66
Figure 11:	X2X Link interface.....	67
Figure 12:	4PPC70.xxxx-21x - 2 CAN bus.....	68
Figure 13:	4PPC70.xxxx-22x - 1 CAN bus interface / 1 RS232 interface.....	69
Figure 14:	4PPC70.xxxx-23x - 1 CAN bus interface / 1 RS485 interface.....	70
Figure 15:	Power supply.....	70
Figure 16:	Dimensions - 4PPC70.057x-2xx - 4PPC70.0573.....	72
Figure 17:	Dimensions - 4PPC70.057x-2xx - 4PPC70.057L.....	73
Figure 18:	Dimensions - 4PPC70.070x-2xx - 4PPC70.0702.....	74
Figure 19:	Dimensions - 4PPC70.070x-2xx - 4PPC70.070M.....	75
Figure 20:	Dimensions - 4PPC70.101x-2xx - 4PPC70.101G.....	76
Figure 21:	Dimensions - 4PPC70.101x-2xx - 4PPC70.101N.....	77
Figure 22:	Spacing for air circulation - Rear view.....	78
Figure 23:	Spacing for air circulation - Side view.....	79
Figure 24:	Power Panel - Mounting orientations.....	80
Figure 25:	"Set IP Parameters" example.....	81
Figure 26:	Performing a "Rebuild".....	81
Figure 27:	"Operating System Transfer" - Settings.....	82
Figure 28:	Grounding.....	82
Figure 29:	The midpoint between 2 points of contact.....	83
Figure 30:	Viewing angles.....	89

Table 1:	Manual history.....	4
Table 2:	Organization of safety notices.....	6
Table 3:	Power Panel C-Series - General technical data.....	10
Table 4:	Overview - 4PPC70.057x.....	11
Table 5:	Overview - 4PPC70.070x.....	11
Table 6:	Overview - 4PPC70.101x.....	11
Table 7:	Interfaces.....	12
Table 8:	4PPC70.0573-20W, 4PPC70.0573-20B, 4PPC70.057L-20W, 4PPC70.057L-20B - Order data..	13
Table 9:	4PPC70.0573-21W, 4PPC70.0573-21B, 4PPC70.057L-21W, 4PPC70.057L-21B - Order data..	14
Table 10:	4PPC70.0573-22W, 4PPC70.0573-22B, 4PPC70.057L-22W, 4PPC70.057L-22B - Order data..	15
Table 11:	4PPC70.0573-23W, 4PPC70.0573-23B, 4PPC70.057L-23W, 4PPC70.057L-23B - Order data..	16
Table 12:	4PPC70.0573-20W, 4PPC70.0573-20B, 4PPC70.057L-20W, 4PPC70.057L-20B - Technical data.....	17
Table 13:	4PPC70.0573-21W, 4PPC70.0573-21B, 4PPC70.057L-21W, 4PPC70.057L-21B - Technical data.....	20
Table 14:	4PPC70.0573-22W, 4PPC70.0573-22B, 4PPC70.057L-22W, 4PPC70.057L-22B - Technical data.....	23
Table 15:	4PPC70.0573-23W, 4PPC70.0573-23B, 4PPC70.057L-23W, 4PPC70.057L-23B - Technical data.....	26
Table 16:	4PPC70.0702-20W, 4PPC70.0702-20B, 4PPC70.070M-20W, 4PPC70.070M-20B - Order data	29
Table 17:	4PPC70.0702-21W, 4PPC70.0702-21B, 4PPC70.070M-21W, 4PPC70.070M-21B - Order data	30
Table 18:	4PPC70.0702-22W, 4PPC70.0702-22B, 4PPC70.070M-22W, 4PPC70.070M-22B - Order data	31
Table 19:	4PPC70.0702-23W, 4PPC70.0702-23B, 4PPC70.070M-23W, 4PPC70.070M-23B - Order data	32
Table 20:	4PPC70.0702-20W, 4PPC70.0702-20B, 4PPC70.070M-20W, 4PPC70.070M-20B - Technical data.....	33
Table 21:	4PPC70.0702-21W, 4PPC70.0702-21B, 4PPC70.070M-21W, 4PPC70.070M-21B - Technical data.....	36
Table 22:	4PPC70.0702-22W, 4PPC70.0702-22B, 4PPC70.070M-22W, 4PPC70.070M-22B - Technical data.....	39
Table 23:	4PPC70.0702-23W, 4PPC70.0702-23B, 4PPC70.070M-23W, 4PPC70.070M-23B - Technical data.....	42
Table 24:	4PPC70.101G-20W, 4PPC70.101G-20B, 4PPC70.101N-20W, 4PPC70.101N-20B - Order data	45
Table 25:	4PPC70.101G-21W, 4PPC70.101G-21B, 4PPC70.101N-21W, 4PPC70.101N-21B - Order data	46
Table 26:	4PPC70.101G-22W, 4PPC70.101G-22B, 4PPC70.101N-22W, 4PPC70.101N-22B - Order data	47
Table 27:	4PPC70.101G-23W, 4PPC70.101G-23B, 4PPC70.101N-23W, 4PPC70.101N-23B - Order data	48
Table 28:	4PPC70.101G-20W, 4PPC70.101G-20B, 4PPC70.101N-20W, 4PPC70.101N-20B - Technical data.....	49
Table 29:	4PPC70.101G-21W, 4PPC70.101G-21B, 4PPC70.101N-21W, 4PPC70.101N-21B - Technical data.....	52
Table 30:	4PPC70.101G-22W, 4PPC70.101G-22B, 4PPC70.101N-22W, 4PPC70.101N-22B - Technical data.....	55
Table 31:	4PPC70.101G-23W, 4PPC70.101G-23B, 4PPC70.101N-23W, 4PPC70.101N-23B - Technical data.....	58
Table 32:	Diagnostic LEDs - 4PPC70.xxxx-2xx.....	61
Table 33:	Diagnostic LEDs - 4PPC70.xxx-20x - "S/E" LED - Ethernet mode.....	61
Table 34:	Diagnostic LEDs 4PPC70.xxx-20x - "S/E" LED - POWERLINK - Error.....	62
Table 35:	Diagnostic LEDs - 4PPC70.xxx-20x - "S/E" LED - Status.....	62
Table 36:	Diagnostic LEDs 4PPC70.xxxx-20x - System failure error codes.....	63
Table 37:	Ethernet and POWERLINK LEDs.....	63
Table 38:	POWERLINK interface - Pinout.....	65
Table 39:	Ethernet interface - Pinout.....	65
Table 40:	USB interface.....	66
Table 41:	X2X Link interface.....	67
Table 42:	4PPC70.xxxx-21x - 2 CAN bus.....	68
Table 43:	4PPC70.xxxx-22x - 1 CAN bus interface / 1 RS232 interface.....	69
Table 44:	4PPC70.xxxx-23x - 1 CAN bus interface / 1 RS485 interface.....	70
Table 45:	Power supply.....	71
Table 46:	Overview of standards.....	84

Table 47:	International certifications.....	84
Table 48:	C-Series overview.....	85
Table 49:	0TB6102.2010-01, 0TB6102.2110-01 - Order data.....	86
Table 50:	0TB6102.2010-01, 0TB6102.2110-01 - Technical data.....	86
Table 51:	0TB5104.2110-01, 0TB5106.2110-01 - Order data.....	87
Table 52:	0TB5104.2110-01, 0TB5106.2110-01 - Technical data.....	87
Table 53:	Chemical resistance of the panel overlay.....	89

0TB5104.2110-01.....	87
0TB5106.2110-01.....	87
0TB6102.2010-01.....	86
0TB6102.2110-01.....	86
4PPC70.0573-20B.....	13
4PPC70.0573-20W.....	13
4PPC70.0573-21B.....	14
4PPC70.0573-21W.....	14
4PPC70.0573-22B.....	15
4PPC70.0573-22W.....	15
4PPC70.0573-23B.....	16
4PPC70.0573-23W.....	16
4PPC70.057L-20B.....	13
4PPC70.057L-20W.....	13
4PPC70.057L-21B.....	14
4PPC70.057L-21W.....	14
4PPC70.057L-22B.....	15
4PPC70.057L-22W.....	15
4PPC70.057L-23B.....	16
4PPC70.057L-23W.....	16
4PPC70.0702-20B.....	29
4PPC70.0702-20W.....	29
4PPC70.0702-21B.....	30
4PPC70.0702-21W.....	30
4PPC70.0702-22B.....	31
4PPC70.0702-22W.....	31
4PPC70.0702-23B.....	32
4PPC70.0702-23W.....	32
4PPC70.070M-20B.....	29
4PPC70.070M-20W.....	29
4PPC70.070M-21B.....	30
4PPC70.070M-21W.....	30
4PPC70.070M-22B.....	31
4PPC70.070M-22W.....	31
4PPC70.070M-23B.....	32
4PPC70.070M-23W.....	32
4PPC70.101G-20B.....	45
4PPC70.101G-20W.....	45
4PPC70.101G-21B.....	46
4PPC70.101G-21W.....	46
4PPC70.101G-22B.....	47
4PPC70.101G-22W.....	47
4PPC70.101G-23B.....	48
4PPC70.101G-23W.....	48
4PPC70.101N-20B.....	45
4PPC70.101N-20W.....	45
4PPC70.101N-21B.....	46
4PPC70.101N-21W.....	46
4PPC70.101N-22B.....	47
4PPC70.101N-22W.....	47
4PPC70.101N-23B.....	48
4PPC70.101N-23W.....	48